



# BU406

## NPN PLANAR TRANSISTOR

### SILICON NPN SWITCHING TRANSISTOR

■ DESCRIPTION

The UTC **BU406** is a NPN epitaxial planar transistor. It is a fast switching device for use in horizontal deflection output stages of large screens MTV receivers with 110 CRT.

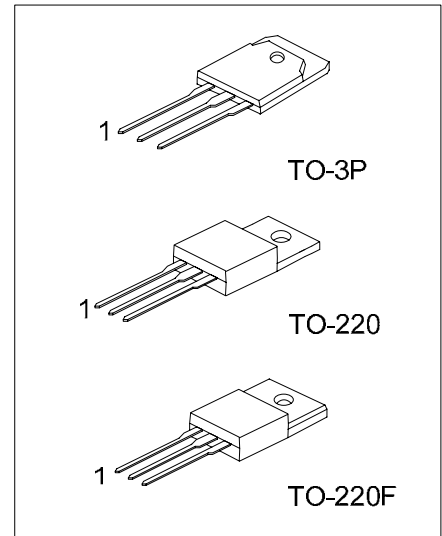

\*Pb-free plating product number: BU406L

■ ORDERING INFORMATION

Order Number		Package	Pin Assignment			Packing
Normal	Lead Free Plating		1	2	3	
BU406-x-TA3-T	BU406L-x-TA3-T	TO-220	B	C	E	Tube
BU406-x-TF3-T	BU406L-x-TF3-T	TO-220F	B	C	E	Tube
BU406-x-T3P-T	BU406L-x-T3P-T	TO-3P	B	C	E	Tube

<p>BU406L-x-TA3-T</p>	<p>(1) T: Tube          (2) TA3: TO:220, TF3: TO-220F, T3P: TO-3P          (3) x: refer to Classification of <math>h_{FE}</math>          (4) L: Lead Free Plating, Blank: Pb/Sn</p>
-----------------------	--

### ■ ABSOLUTE MAXIMUM RATING

PARAMETER	SYMBOL	RATINGS	UNIT
Collector-Base Voltage ( $I_E=0$ )	$V_{CBO}$	400	V
Collector-Emitter Voltage ( $V_{BE}=-1.5V$ )	$V_{CEV}$	400	V
Collector-Emitter Voltage ( $I_B=0$ )	$V_{CEO}$	200	V
Emitter-Base Voltage ( $I_C=0$ )	$V_{EBO}$	6	V
Collector Current	$I_C$	7	A
Collector Peak Current (repetitive)	$I_{CM}$	10	A
Collector Peak Current ( $t_p=10ms$ )	$I_{CM}$	15	A
Base Current	$I_B$	4	A
Collector Dissipation ( $T_C \leq 25$ )	$P_C$	60	W
Junction Temperature	$T_J$	150	
Storage Temperature	$T_{STG}$	-65 ~ +150	

Note Absolute maximum ratings are those values beyond which the device could be permanently damaged. Absolute maximum ratings are stress ratings only and functional device operation is not implied.

### ■ THERMAL DATA

PARAMETER	SYMBOL	RATINGS	UNIT
Thermal Resistance, Junction to Ambient	$\theta_{JA}$	70	/W
Thermal Resistance, Junction to Case	$\theta_{JC}$	2.08	/W

### ■ ELECTRICAL CHARACTERISTICS ( $T_a=25$ )

PARAMETER	SYMBOL	TEST CONDITIONS	MIN	TYP	MAX	UNIT
Collect Cutoff Current ( $V_{BE}=0$ )	$I_{CES}$	$V_{CE}=400V$			5	mA
		$V_{CE}=250V$ $T_C=150^\circ C$			100	$\mu A$
		$V_{CE}=250V$			1	mA
Emitter Cut-off Current ( $I_C=0$ )	$I_{EBO}$	$V_{BE}=6V$			1	mA
Collector-Emitter Saturation Voltage	$V_{CE(SAT)^*}$	$I_C=5A, I_B=0.5A$			1	V
Base-Emitter Saturation Voltage	$V_{BE(SAT)^*}$	$I_C=5A, I_B=0.5A$			1.2	V
DC Current Gain	$h_{FE}$	$V_{CE}=10V, I_C=500mA$	70		240	
Transition Frequency	$f_T$	$I_C=500mA, V_{CE}=10V$	10			MHz
Turn-off Time	$t_{OFF}$	$I_C=5A, I_B=0.5A$			0.75	$\mu s$
Second Breakdown Collector Current	$I_{s/b}$	$V_{CE}=40V, t=10ms$		4		A

\* Pulse duration=300 $\mu s$ , duty cycle 1.5%

### ■ CLASSIFICATION OF $h_{FE}$

RANK	A	B
RANGE	70 ~ 120	110 ~ 240

## TYPICAL CHARACTERISTICS

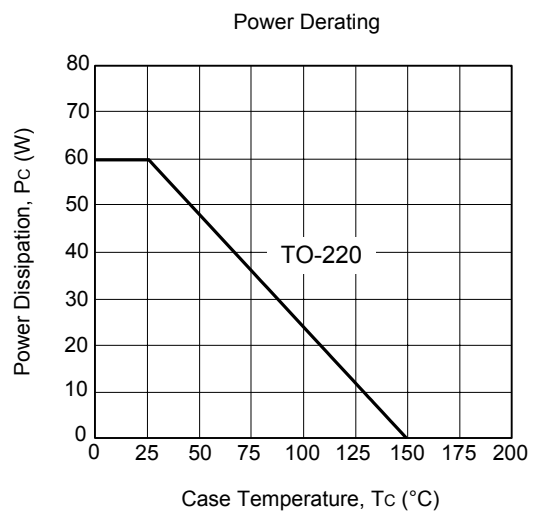
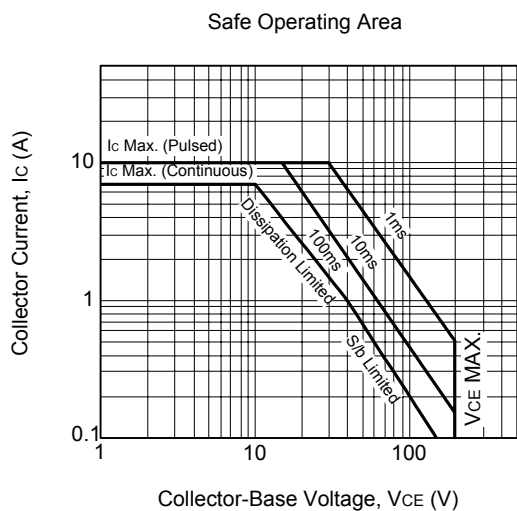
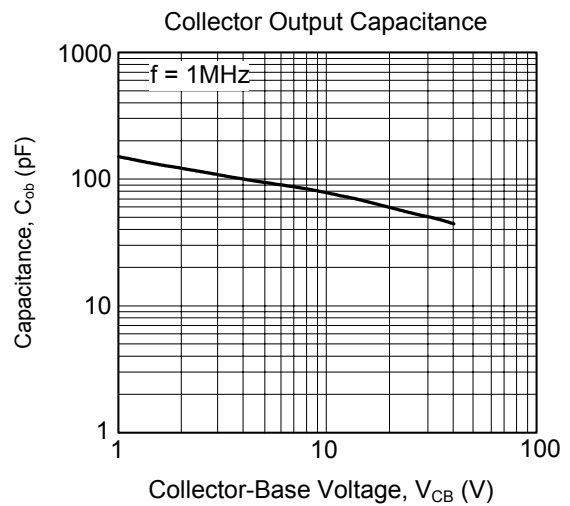
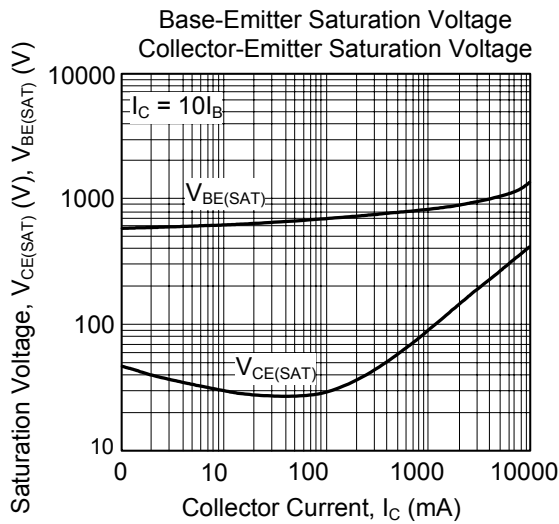
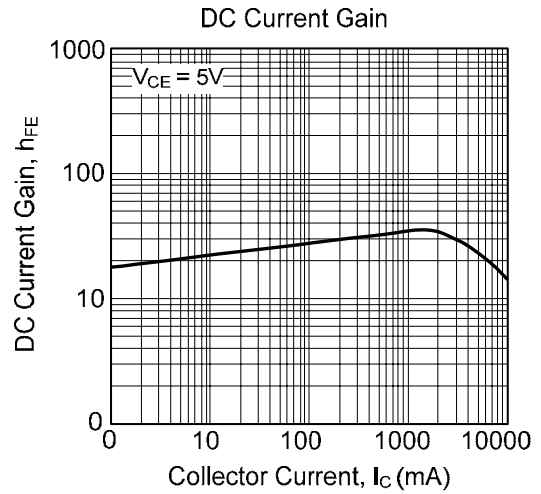
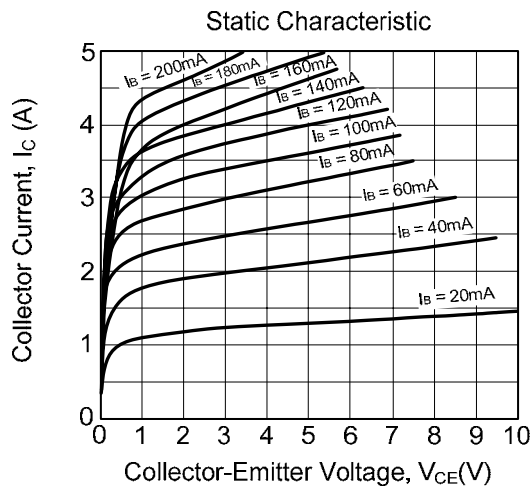

UTC assumes no responsibility for equipment failures that result from using products at values that exceed, even momentarily, rated values (such as maximum ratings, operating condition ranges, or other parameters) listed in products specifications of any and all UTC products described or contained herein. UTC products are not designed for use in life support appliances, devices or systems where malfunction of these products can be reasonably expected to result in personal injury. Reproduction in whole or in part is prohibited without the prior written consent of the copyright owner. The information presented in this document does not form part of any quotation or contract, is believed to be accurate and reliable and may be changed without notice.