



## Refond Data Sheet For 5mm Super White LED

Part No: **RF5A3SWN4-N**

AVAILABLE FROM □

□

MANTECH ELECTRONICS □

□

TEL : 011-493-9307 □

FAX : 011-493-9319



Features	
<ul style="list-style-type: none"> <li>• Standard T-1 Diameter Type Package.</li> <li>• General Purpose Leads</li> <li>• Reliable and Rugged</li> </ul>	
<b>Part No.</b>	RF5A3SWN4-N
<b>Lens Color</b>	Water Clear
<b>Source Color</b>	Super White

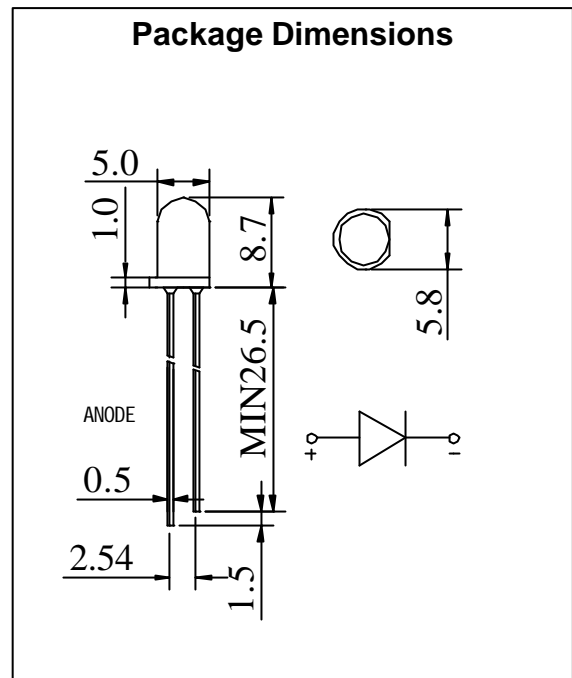

## Typical Characteristic

Forward Current vs. Chromaticity Coordinate ( D)

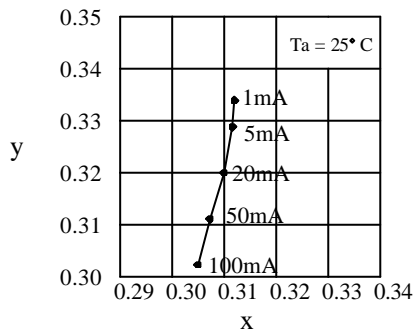

Spectrum

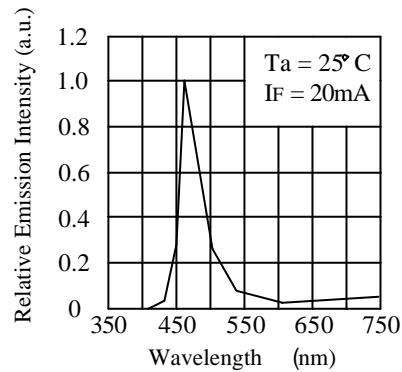

Ambient Temperature vs. Chromaticity Coordinate ( D)

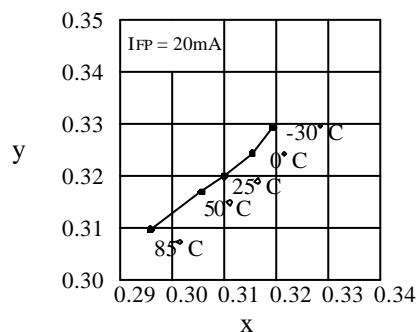

Directivity (Angle : 15°)

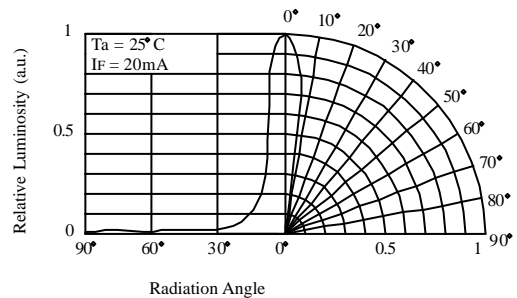



## Typical Characteristic

Forward Voltage vs.  
Forward Current

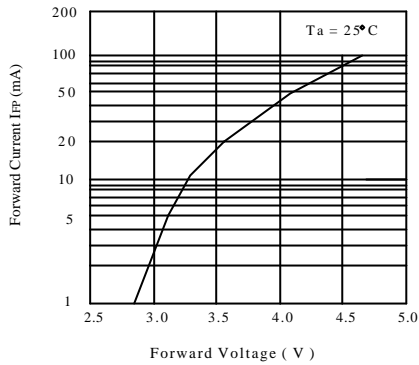

Forward Current vs.  
Relative Luminosity

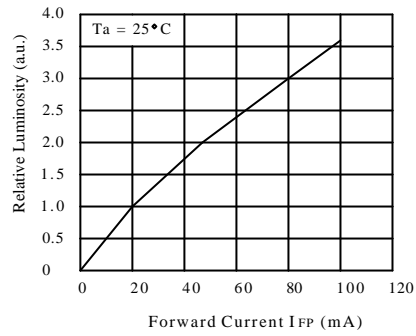

Ambient Temperature vs.  
Forward Voltage

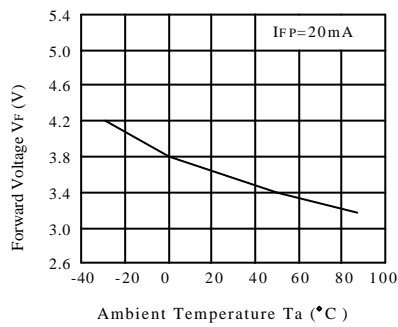

Ambient Temperature vs.  
Relative Luminosity

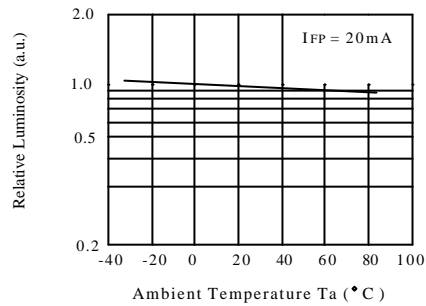

Duty Ratio vs.  
Allowable Forward Current

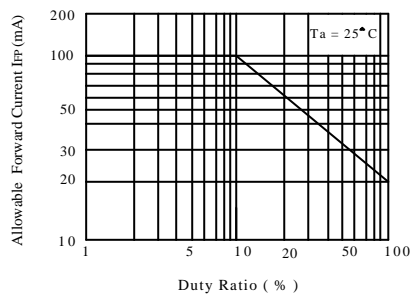

Ambient Temperature vs.  
Allowable Forward Current

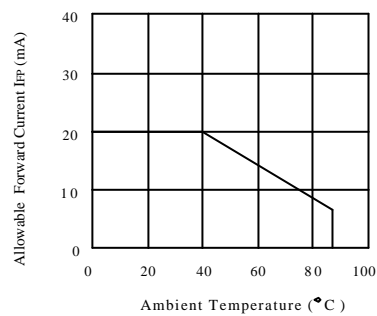

**Absolute Maximum Ratings at Ta=25**

Parameter	MAX.	Unit
Power Dissipation	100	mW
Peak Forward Current (1/10 Duty Cycle, 0.1ms Pulse Wide)	100	mA
Continuous Forward Current	20	mA
Derating Linear From 50°C	0.4	mA/°C
Reverse Voltage	5	V
Operating Temperature Range	-40°C to +80°C	
Storage Temperature Range	-40°C to +80°C	
Lead Soldering Temperature [ 4mm(.157") From Body]	260°C for 3 Seconds	

**Electrical Optical Characteristics at Ta=25**

Parameter	Symbol	Min.	Typ.	Max.	Unit	Test Condition
Luminous Intensity	I <sub>v</sub>	8000	---	10000	mcd	I <sub>F</sub> = 20mA (Note 7)
Viewing angle	2?½	---	15	---	Deg	(Note 8)
$x = \frac{X}{X+Y+Z} = \frac{Red}{Red+Green+Blue}$	X	---	0.29	---	---	I <sub>F</sub> = 20mA(Note 9)
$y = \frac{Y}{X+Y+Z} = \frac{Green}{Red+Green+Blue}$	Y	---	0.27	---	---	I <sub>F</sub> = 20mA(Note 9)
Forward Voltage	V <sub>F</sub>	3.0	---	4.0	V	I <sub>F</sub> = 20mA
Reverse Current	I <sub>R</sub>	---	---	50	µA	V <sub>R</sub> = 5V

**Notes:**

- All dimensions are in millimeter.
- Tolerance is ±0.25mm(.01") unless others otherwise noted.
- Protruded resin under flanges is 1.0mm(0.4") max.
- Lead spacing is measured where the leads emerge from the package.
- Specifications are subject to change without notice.
- Caution in ESD: Static Electricity and surge damages the LED. It is recommended to use a wrist band or anti-electrostatic glove when handling the LED. All devices, equipment and machinery must be properly grounded.
- Luminous intensity is measured with a light sensor and filter combination that approximates the CIE eye-response curve.
- $_{1/2}$  is the off-axis angle at which the luminous intensity is half the axial luminous intensity.
- It use many parameters that correspond to the CIE 1931 2°  
X, Y, and Z are CIE1931 2° values of Red, Green and Blue content of the measurement.



## CAUTIONS- Super Bright LED

Because the white LEDs are made by combining Blue LEDs and special phosphors. Hence, the color of White LEDs is changed a little by an operation current. Care should be taken after due consideration when using LEDs.

1. Lead Forming
  - a. At least 3mm from the base of the epoxy bulb should be kept when forming leads.
  - b. Do not use the base of the leadframe as a fulcrum during lead forming.  
Lead forming should be done before soldering.
  - c. Because the stress to the base may damage the characteristics or it may break the LEDs, do not apply any bending stress to the base of the lead
  - d. When mounting the LEDs onto a PCB, the holes on the circuit board should be exactly aligned with the leads of the LEDs. Stress at the leads should be avoided when the LEDs are mounted on the PCB, because it causes damage to the epoxy resin and this will degrade the LEDs.
- (2) Storage
  - a. The LEDs should be stored at 30°C or less and 70%RH or less after being shipped and the storage life limits are 3 months.
  - b. If the LEDs are stored more than 3 months, they can be stored for a year in a sealed container with a nitrogen atmosphere and moisture absorbent material.
  - c. Please avoid rapid transitions in ambient temperature, especially, in high humidity environments where condensation can occur.
- (3) Static Electricity
  - a. Static electricity or surge voltage damages the LEDs.
  - b. It is recommended that a wristband or an anti-electrostatic glove be used when handling the LEDs.
  - c. All devices, equipment and machinery must be properly grounded.
  - d. It is recommended that measures be taken against surge voltage to the equipment that mounts the LEDs.
  - e. Damaged LEDs will show some unusual characteristics such as the leak current remarkably increases, the forward voltage becomes lower, or the LEDs do not light at the low current.  
Criteria: ( $V_F > 2.0V$  at  $I_F = 0.5mA$ )
- (5) Heat Generation
  - a. Thermal design of the end product was most important. Please consider the heat generation of the LED when making the system design.
  - b. The thermal resistance of the circuit board and density of LED placement on the board, as well as other components was the important factor affecting the coefficient of temperature increase per input electric power. It must be avoided intense heat generation and operate within the maximum ratings given in the specification.
  - c. The operating current should be decided after considering the ambient maximum temperature of LEDs.
- (6) Cleaning
  - a. It is recommended that isopropyl alcohol be used as a solvent for cleaning the LEDs. When using other solvents, it should be confirmed beforehand whether the solvents will dissolve the resin or not. Freon solvents should not be used to clean the LEDs because of worldwide regulations.
  - b. Do not clean the LEDs by the ultrasonic. When it is absolutely necessary, the influence of ultrasonic cleaning on the LEDs depends on factors such as ultrasonic power and the assembled condition. Before cleaning, a pre-test should be done to confirm whether any damage to the LEDs would occur.
- (7) Safety Guideline for Human Eyes
  - a. In 1993, the International Electric Committee (IEC) issued a standard concerning laser product safety (IEC 825-1). Since then, this standard has been applied for diffused light sources (LEDs) as well as lasers. In 1998 IEC 60825-1 Edition 1.1 evaluated the magnitude of the light source.
  - b. In 2001 IEC 60825-1 Amendment 2 converted the laser class into 7 classes for end products.
  - c. Components are excluded from this system. Products which contain visible LEDs are now classified as class 1. Products containing UV LEDs can be classified as class 2 in cases where viewing angles are narrow, optical manipulation intensifies the light, and/or the energy emitted is high. For these systems it is recommended to avoid long term exposure. It is also recommended to follow the IEC regulations regarding safety and labeling of products.
- (8) Soldering Condition for LED Lamps
  - a. EPOXY RESIN of LED  
Epoxy resin for LED needs to be cured within some temperature range with enough time, otherwise it will not harden enough then and moisture in the air will penetrate into epoxy day by day. After some period later, the epoxy of LED may crack inside and it will reduce the lifetime of the LED lamps. Because of this reason, we REFOND had precisely controlled as in the 2nd Statement.
  - b. Temperature of Glass ( $T_g$  Point)  
For ensure the epoxy resin is hard enough, a good process control for epoxy resin ENDCAP process was required, such as precise temperature profile of the oven, exactly time for curing and good selection for epoxy resin. After that we need to measure the  $T_g$  point for checking the epoxy resin is hard enough or not.  $T_g$  point should be controlled in range 125-135 centi-grade, if  $T_g$  lower than 125 degree, it will make the epoxy soft. When soldering higher than 135 degree, it will make the epoxy too hard and the epoxy will crack inside easily.
  - c. For Automatic Soldering
    - (a) All of soldering equipment needs to check temperature on top of PCB for soldering LED as record.
    - (b) Pre-heat temperature must be below  $T_g$  point, otherwise LED will be soft soldering and broken the bonding gold wire inside.
    - (c) The soldering condition needs to be below 5 seconds with 260 centi-grade or lower of each soldering point.



- (d) The soldering PCB with LED can't have any vibration or shock after soldering because inside LED epoxy still soft, and this action will cause gold wire broken inside. The best way is to have cooling fan for cooling down shortly.
- d. For Manually soldering
  - (a) When use hand soldering with extension wire, it is suggested that a fixture for soldering is needed to prevent any strength inside when head is transferring to epoxy through LED leads. Otherwise, it might have gold wire broken inside.
  - (b) When use hand soldering with PCB insertion, it must make sure the pitch of OCB for LED leads are the same as LED lead pitch. Otherwise there might have strength transfer to inside epoxy broken gold wire when soldering.
- e. The size of the PCB for automatic soldering
  - (a) It is very important that PCB will have a little bit bent when soldering, this phenomenon especially for large PCB size. When there are some higher defect rate for LED after soldering, it must check the PCB size and the PCB is bent or not in this soldering. If this phenomenon happen, the LED leads will be a little bit bent and the gold wire inside may be broken.
  - (b) It will be good for the LED circuit application if a small size PCB was used.
  - (c) Then larger size PCB was use; it needs to have special fixture to preventing PCB bending when soldering.
- (9) Others
  - a. Care must be taken to ensure that the reverse voltage will not exceed the absolute maximum rating when using the LEDs with matrix drive. Keeping the Normal Forward to 20 mA.

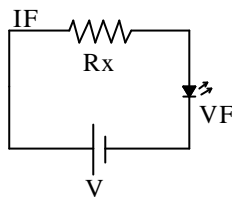

$$I_F = \frac{V - V_F}{R_x}$$

- b. The LEDs described in this brochure are intended to be used for ordinary electronic equipment (such as office equipment, communications equipment, measurement instruments and household appliances). Consult Refond's sales staff in advance for information on the applications in which exceptional quality and reliability are required, particularly when the failure or malfunction of the LEDs may directly jeopardize life or health (such as for airplanes, aerospace, submersible repeaters, nuclear reactor control systems, automobiles, traffic control equipment, life support systems and safety devices).
- c. User shall not reverse engineer by disassembling or analysis of the LEDs without having prior written consent from Refond. When defective LEDs are found, the User shall inform Refond directly before disassembling or analysis.
- d. The formal specifications must be exchanged and signed by both parties before large volume purchase begins.
- e. The appearance and specifications of the product may be modified for improvement without notice.

AVAILABLE FROM

MANTECH ELECTRONICS

TEL : 011-493-9307

FAX : 011-493-9319