



■ Features :

- AC input 180 ~ 264VAC
- AC input active surge current limiting
- High efficiency up to 90%
- Built-in active PFC function, PF>0.95
- Protections: Short circuit / Overload / Over voltage / Over temperature / Fan alarm
- Forced air cooling by built-in DC with fan speed control function
- Output voltage can be trimmed between 20~110% of the rated output voltage
- High power density 15.6W/inch³
- Current sharing up to 2 units
- Alarm signal output (relay contact and TTL signal)
- Built-in 12V/0.1A auxiliary output for remote control
- Built-in remote ON-OFF control
- Built-in remote sense function
- 3 years warranty



SPECIFICATION

MODEL	RSP-3000-12	RSP-3000-24	RSP-3000-48	
OUTPUT	DC VOLTAGE	12V	24V	48V
	RATED CURRENT	200A	125A	62.5A
	CURRENT RANGE	0 ~ 200A	0 ~ 125A	0 ~ 62.5A
	RATED POWER	2400W	3000W	3000W
	RIPPLE & NOISE (max.) Note.2	150mVp-p	150mVp-p	200mVp-p
	VOLTAGE ADJ. RANGE	10.8 ~ 13.2V	22 ~ 28V	43 ~ 56V
	VOLTAGE TOLERANCE Note.3	±1.0%	±1.0%	±1.0%
	LINE REGULATION	±0.5%	±0.5%	±0.5%
	LOAD REGULATION	±0.5%	±0.5%	±0.5%
SETUP, RISE TIME	1000ms, 80ms at full load			
HOLD UP TIME (Typ.)	10ms at full load			
INPUT	VOLTAGE RANGE	180 ~ 264VAC 254 ~ 370VDC		
	FREQUENCY RANGE	47 ~ 63Hz		
	POWER FACTOR (Typ.)	0.95/230VAC at full load		
	EFFICIENCY (Typ.)	86%	90%	90.5%
	AC CURRENT (Typ.)	20A/180VAC 16A/230VAC		
	INRUSH CURRENT (Typ.)	60A/230VAC		
LEAKAGE CURRENT	<2.0mA / 240VAC			
PROTECTION	OVERLOAD	100 ~ 110% rated output power User adjustable continuous constant current limiting or constant current limiting with delay shutdown after 5 seconds, re-power on to recover		
	OVER VOLTAGE	13.8 ~ 16.8V	28.8 ~ 33.6V	57.6 ~ 67.2V
	OVER TEMPERATURE	90°C±5°C(12V), 110°C±5°C(24V), 105°C±5°C(48V) (TSW1: detect on heatsink of power transistor) 90°C±5°C(12V), 85°C±5°C(24V), 75°C±5°C(48V) (TSW2: detect on heatsink of o/p diode) Protection type: Shut down o/p voltage, recovers automatically after temperature goes down		
FUNCTION	AUXILIARY POWER(AUX)	12V@0.1A(Only for Remote ON/OFF control)		
	REMOTE ON/OFF CONTROL	Please see the Function Manual		
	ALARM SIGNAL OUTPUT	Please see the Function Manual		
	OUTPUT VOLTAGE TRIM	2.4 ~ 13.2V	4.8 ~ 28V	9.6 ~ 56V
	CURRENT SHARING	Please see the Function Manual		
ENVIRONMENT	WORKING TEMP.	-20 ~ +70°C (Refer to output load derating curve)		
	WORKING HUMIDITY	20~90% RH non-condensing		
	STORAGE TEMP., HUMIDITY	-40 ~ +85°C, 10 ~ 95% RH		
	TEMP. COEFFICIENT	±0.05%/°C (0 ~ 50°C)		
	VIBRATION	10 ~ 500Hz, 2G 10min./1cycle, 60min. each along X, Y, Z axes		
SAFETY & EMC (Note 4)	SAFETY STANDARDS	UL60950-1, TUV EN60950-1 approved		
	WITHSTAND VOLTAGE	I/P-O/P:3KVAC I/P-FG:1.5KVAC O/P-FG:0.5KVAC		
	ISOLATION RESISTANCE	I/P-O/P, I/P-FG, O/P-FG:100M Ohms / 500VDC / 25°C / 70% RH		
	EMI CONDUCTION & RADIATION	Compliance to EN55022 (CISPR22)		
	HARMONIC CURRENT	Compliance to EN61000-3-2,-3		
OTHERS	EMS IMMUNITY	Compliance to EN61000-4-2,3,4,5,6,8,11; ENV50204, EN55024, light industry level, criteria A		
	MTBF	104.5K hrs min. MIL-HDBK-217F (25°C)		
	DIMENSION	278*177.8*63.5mm (L*W*H)		
	PACKING	4Kg; 4pcs/16Kg/1.89CUFT		
NOTE	<p>1. All parameters NOT specially mentioned are measured at 230VAC input, rated load and 25°C of ambient temperature.</p> <p>2. Ripple & noise are measured at 20MHz of bandwidth by using a 12" twisted pair-wire terminated with a 0.1uf & 47uf parallel capacitor.</p> <p>3. Tolerance : includes set up tolerance, line regulation and load regulation.</p> <p>4. The power supply is considered a component which will be installed into a final equipment. The final equipment must be re-confirmed that it still meets EMC directives.</p>			

Mechanical Specification

Case No.982B Unit:mm

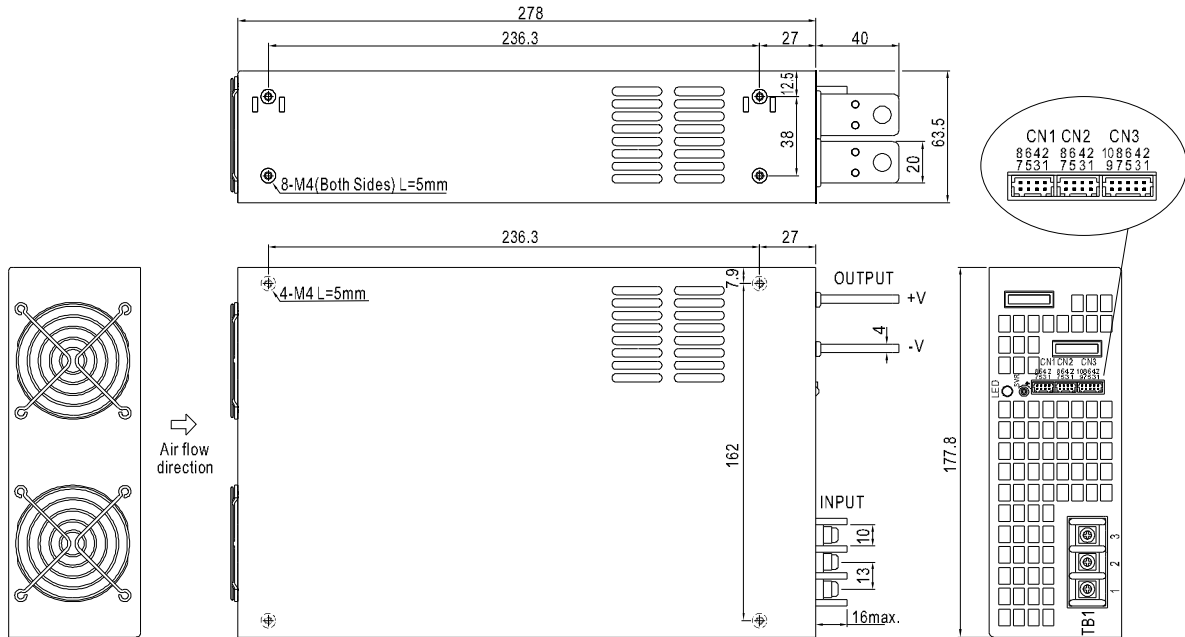

AC Input Terminal Pin No. Assignment

Pin No.	Assignment
1	AC/L
2	AC/N
3	FG \perp

Control Pin No. Assignment(CN1,CN2) : HRS DF11-8DP-2DS or equivalent

Pin No.	Assignment	Pin No.	Assignment	Mating Housing	Terminal
1	RCG	5,7	-S	HRS DF11-8DS or equivalent	HRS DF11-**SC or equivalent
2	RC	6	CS(Current Share)		
3	PV	8	+S		
4	PS				

RCG: Remote ON/OFF Ground -S: -Remote Sensing
 RC : Remote ON/OFF CS: Load Share
 PV :Output Voltage External Control +S: +Remote Sensing
 PS : Reference Voltage Terminal

Control Pin No. Assignment(CN3) : HRS DF11-10DP-2DS or equivalent

Pin No.	Assignment	Pin No.	Assignment	Pin No.	Assignment	Pin No.	Assignment	Mating Housing	Terminal
1	P OK GND	4	P OK2	7	AUXG	10	OL-SD	HRS DF11-10DS or equivalent	HRS DF11-**SC or equivalent
2	P OK	5	RCG	8	AUX				
3	P OK GND2	6	RC	9	OLP				

P OK GND: Power OK Ground RCG: Remote ON/OFF Ground AUX: Auxiliary Output
 P OK: Power OK Signal (Relay Contact) RC: Remote ON/OFF OLP: OLP Signal
 P OK2: Power OK Signal (TTL Signal) AUXG: Auxiliary Ground OL-SD: OLP Shutdown Signal

Block Diagram

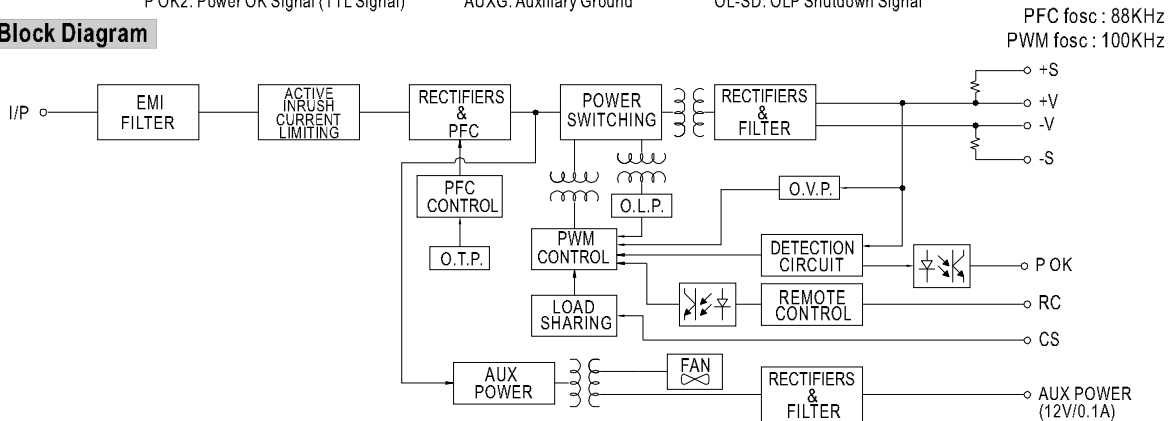

Derating Curve

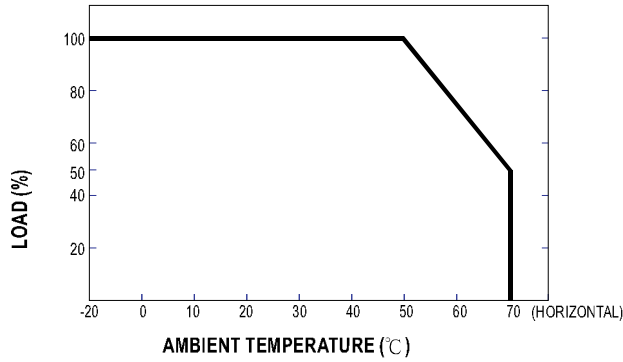

Static Characteristics

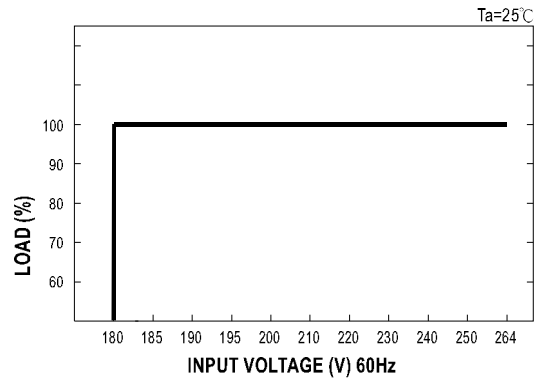

Function Manual

1. Remote ON/OFF

- (1) Remote ON/OFF control becomes available by applying voltage in CN1 & CN2 & CN3.
- (2) Table 1.1 shows the specification of Remote ON/OFF function.
- (3) Fig. 1.2 shows the example to connect Remote ON/OFF control function.

Table 1.1 Specification of Remote ON/OFF

Connection Method	Fig. 1.2(A)	Fig. 1.2(B)	Fig. 1.2(C)
Output on	SW Open	SW Open	SW Close
Output off	SW Close	SW Close	SW Open

Fig. 1.2 Examples of connecting remote ON/OFF

(A) Using external voltage source

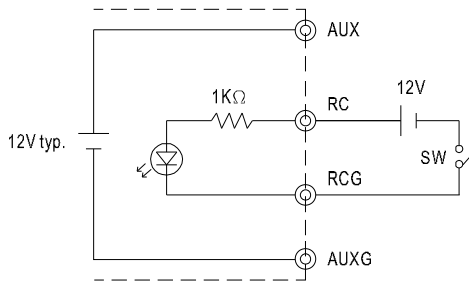

(B) Using internal 12V auxiliary output

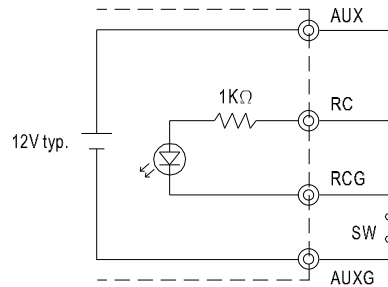

(C) Using internal 12V auxiliary output

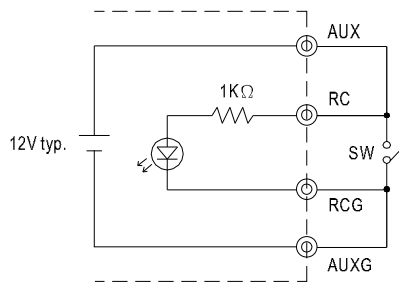

2. Alarm Signal Output

- (1) Alarm signal is sent out through "P OK" & "P OK GND" and P OK2 & P OK GND2 pins.
- (2) An external voltage source is required for this function.
- (3) Table 2.1 explain the alarm function built-in the power supply.

Function	Description	Output of alarm(P OK, Relay Contact)	Output of alarm(P OK2, TTL Signal)
P OK	The signal is "Low" when the power supply is above 80% of the rated output voltage-Power OK	Low (0.5V max at 500mA)	Low (0.5V max at 10mA)
	The signal turns to be "High" when the power supply is under 80% of the rated output voltage-Power Fail	High or open (External applied voltage, 500mA max.)	High or open (External applied voltage, 10mA max.)

Table 2.1 Explanation of alarm

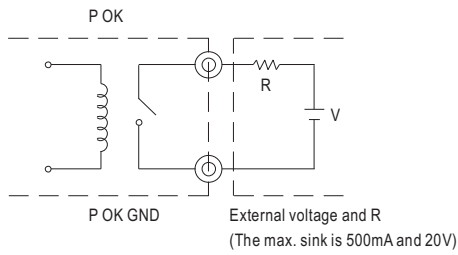

Fig. 2.2 Internal circuit of P OK (Relay, total is 10W)

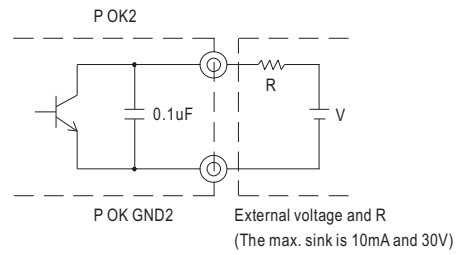

Fig. 2.3 Internal circuit of P OK2 (Open collector method)

3. Output Voltage TRIM

- (1) Connecting an external DC source between PV and-S on CN1 or CN2 that is shown in Fig. 3.1.
- (2) Adjustment of output voltage is possible between 20~110%(Typ.) of the rated output which is shown in Fig. 3.2. Reducing output current is required when the output voltage is trimmed up.

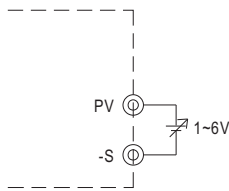

Fig. 3.1 Add on 1~6V external voltage

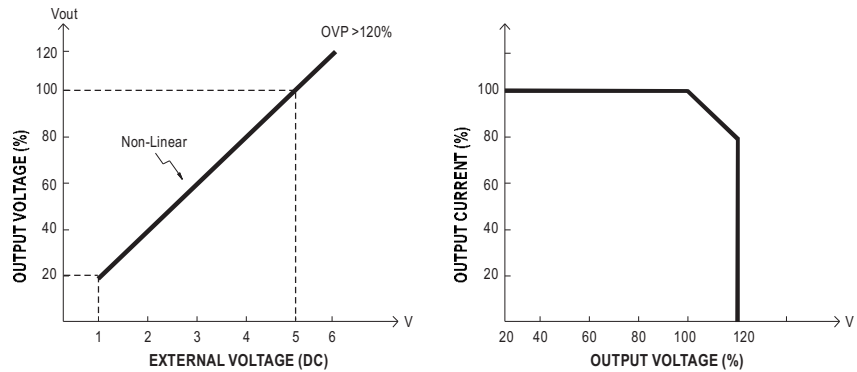
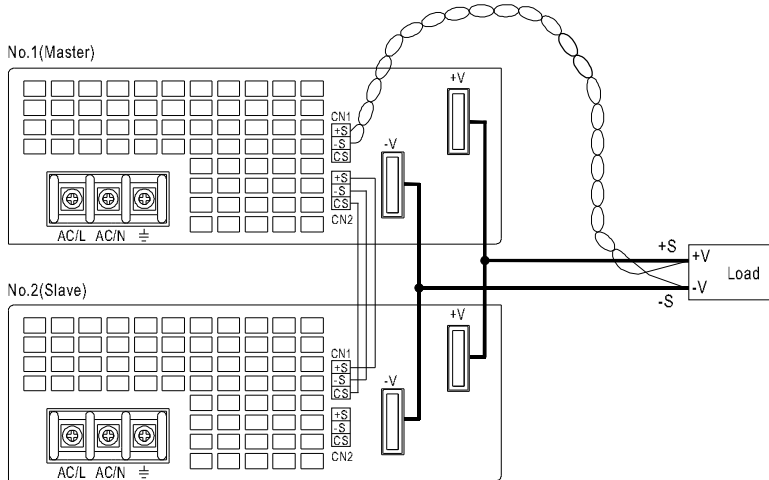

Fig. 3.2 Output voltage trimming

4. Current Sharing

- (1) Parallel operation is available by connecting the units shown as below (+S, -S and CS are connected mutually in parallel);
- (2) The voltage difference among each output should be minimized that less than $\pm 2\%$ is required.
- (3) The total output current must not exceed the value determined by the following equation.
(Output current at parallel operation) = (The rated current per unit) x (Number of unit) x 0.9
- (4) In parallel operation 2 units is the maximum, please consult the manufacturer for other applications.
- (5) When remote sensing is used in parallel operation, the sensing wire must be connected only to the master unit.
- (6) Wires of remote sensing should be kept at least 10 cm from input wires.



- (7) Under parallel operation, the O.L.P. function can only choose "constant current limiting with delay shut down".
- (8) Under parallel operation, the "output voltage trim" function is not available.

5. Select O.L.P mode

- (1) Remove the shorting connector on CN3 that is shown in Fig 5.1, the O.L.P. mode will be "continuous constant current limiting".
- (2) Insert the shorting connector on CN3 that is shown in Fig 5.2, the O.L.P. mode will be "constant current limiting with delay shutdown after 5 seconds, re-power on to recover".

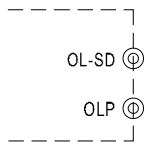

Fig. 5.1 Remove the CN3

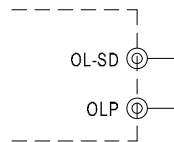

Fig. 5.2 Insert the CN3