

Fujitsu General Purpose Relays

FRL-260 Series

4PDT-3A, 3PDT-5A, DPDT-10A, SPDT-15A

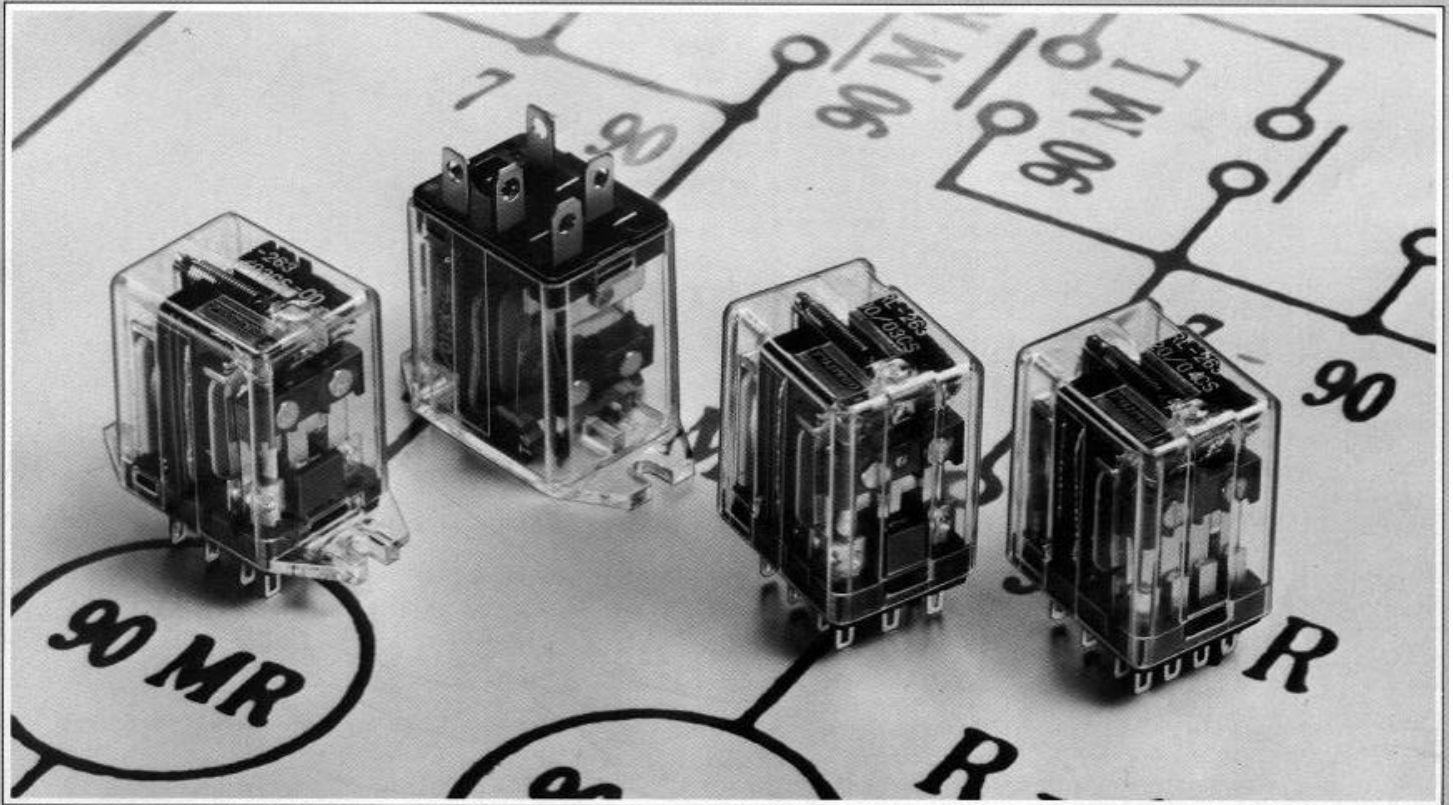

The FRL-260 series relays with proven performance and top quality have been designed with emphasis on reliability, safety, cost performance and applicability to a wide range of uses.

These relays provide SPDT to 4PDT contacts, which are offered for contact ratings from 1 amps to 15 amps at 30V DC or 240V AC, resistive. Moreover, they are also available with 4 transfer bifurcated contacts that enable them to meet signal level or other light loads.

The FRL-260 series relays are available in both DC- and AC-rated coils, and with a selection of mountings, such as solder, plug-in, P.C. board and quick connect terminals.

The FRL-260 series is UL recognized (File No. E63614/E63615) and C.S.A. certified (File No. LR40304).

MOBICON
Electronic Components



GENERAL PURPOSE RELAYS

Specifications

Item	Specification
Contact arrangement and rating	See Series Table and Contact Ratings
Contact material	See Series Table
Contact resistance (initial value)	Standard (silver, silver-cadmium oxide): 100 M Ω max. (at 6V DC, 1A) Low-level (gold overlay silver): 50 m Ω max. (at 6V DC, 0.1A)
Coil power dissipation	DC: 0.9W AC: 1.2VA (at 60 Hz) 1.4VA for 200 to 240V (at 60 Hz)
Coil temperature rise	DC: Approx. 45°C AC: Approx. 45°C Approx. 50°C for 200 to 240V
Insulation resistance	100 M Ω min. (at 500V DC) initial value
Dielectric withstand voltage	Between open contacts: 1,000V AC for 1 minute Between coil and contacts: 1,500V AC for 1 minute
Vibration	10 Hz to 50 Hz (0.5 mm dual amplitude)
Shock	Malfunctions: 10G (11 ms) Endurance: 50G (11 ms)
Operate time	25 ms max. (at rated voltage, not including bounce time)
Release time	25 ms max. (after rated voltage operations, not including bounce time)
Service life	Mechanical 5 x 10 ⁷ ops. min. (maximum switching frequency 18,000 ops./hr) Electrical See Contact Ratings and Reference Data
Ambient temperature	-30°C to 55°C (Do not freeze when below 0°C) (See Reference Data for details)
Weight	Approx. 35g

How to Order

When ordering, insert the desired voltage designation in the blanks shown in the Series table. (See Coil Ratings table for voltage designations.)



(Examples)

- Standard, UL recognized, JEACL conformance types:
24V DC coil voltage – 263D024/04CS-OE
100V AC coil voltage – 263A100/04CS-OE
- CSA certified types:
Add-CSA to designation
For example: 263D024/04CS-OE-CSA



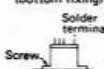
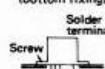

MOBICON
Electronic Components

Series Table

• Medium load type (1A to 5A)

Contact arrangement	Contact form	Contact material	Designation	Contact rating	Contact current range (resistive load)*						Solder, plug-in terminals 	PC board terminals 		Bracket case (bottom fixing) 	Bracket case (bottom fixing) 	Remarks
					1 mA	10 mA	100 mA	1 A	3 A	5 A		10 A	15 A			
1 form C	Single contact	Silver-cadmium oxide	01CS	5A												
2 form C	Single contact	Silver-cadmium oxide	02CV	5A												
3 form C	Single contact	Silver-cadmium oxide	03CS	5A												
4 form C	Single contact	Silver	04CS	3A												
4 form C	Single contact	Silver-cadmium oxide	04CV	5A											4 form C, high power use	
4 form C	Single contact	Gold overlay silver	04CL	3A											4 form C, low level use	
4 form C	Bifurcated contact	Gold overlay silver	04CT	1A											Bifurcated contact, low level use	

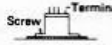
• Heavy load types (10A to 15A)

Contact arrangement	Contact form	Contact material	Designation	Contact rating	Contact current range (resistive load)*						Solder, plug-in type 	PC board type 	Bracket case (upside fixing) 		Bracket case (bottom fixing) 	
					1 mA	10 mA	100 mA	1 A	3 A	5 A			10 A	15 A	Solder terminals	Quick connect terminals (#187)
1 form C**	Single contact	Silver-cadmium oxide	01CK	15A												
1 form A**	Single contact	Silver-cadmium oxide	01AK	15A												
2 form C	Single contact	Silver-cadmium oxide	02CK	10A												

* Contact current range is measured when switching a resistive load at normal temperature and humidity in clean surroundings.

Note that the current range and switchable voltage vary according to the operating environment and switching frequency.

** The 15A heavy-load types are available in two types – standard terminal arrangement and 02 terminal arrangement.

Coil Ratings

	Rated coil voltage	Voltage designation	Coil resistance (±15%)	Rated current (at rated voltage)		Coil identification	Bobbin identification	Pickup voltage (at 20°C)	Dropout voltage (at 20°C)
				50 Hz	60 Hz				
DC	6V	D006	40Ω	Approx. 150mA		Yellow-green	Black	75% max. of rated voltage	10% min. of rated voltage
	12V	D012	160Ω	Approx. 75mA		Light blue			
	24V	D024	650Ω	Approx. 37mA		Blue			
	48V	D048	2,600Ω	Approx. 19mA		Green			
	100V	D100	10,500Ω	Approx. 10mA		Yellow			
AC	6V	A006	10,500Ω	Approx. 220mA	Approx. 200mA	Yellow-green	Gray	80% max. of rated voltage	30% min. of rated voltage
	12V	A012		Approx. 210mA	Approx. 100mA	Light blue			
	24V	A024		Approx. 55mA	Approx. 50mA	Blue			
	48V	A048		Approx. 28mA	Approx. 25mA	Green			
	100V	A100		Approx. 14mA	Approx. 12mA	Yellow			
	120V	A120		Approx. 11mA	Approx. 10mA	Pink			
	200V	A200		Approx. 8mA	Approx. 7mA	Red			
	220V	A220		Approx. 7.2mA	Approx. 6.4mA	Yellow tape (no. 22)			
240V	A240	Approx. 6.6mA	Approx. 5.8mA	Yellow tape (no. 25)					

Note: 5, 9, 18, and 110V DC, and 110V AC types are also available.

MOBICON
Electronic Components

Contact Ratings

Load	Contact arrangement	Contact designation (type name)	Contact rating (resistive load)	Maximum switching voltage	Maximum carrying current	Maximum switching power (resistive load)	Minimum applicable load**	Electrical life (contact rating)
Medium load	1 form C	01CS	30V DC, 240V AC- 5A	120V DC, 250V AC	7A	150W, 1,200VA	0.5W min., 5V min., 10mA min.	5x10 ⁵ ops min.
	2 form C	02CV	30V DC, 240V AC- 5A	120V DC, 250V AC	7A	150W, 1,200VA	0.5W min., 5V min., 10mA min.	5x10 ⁵ ops min.
	3 form C	03CS	30V DC, 240V AC- 5A	120V DC, 250V AC	7A	150W, 1,200VA	0.5W min., 5V min., 10mA min.	5x10 ⁵ ops min.
	4 form C	04CS	30V DC, 120V AC- 3A	120V DC, 250V AC	5A	90W, 360VA	0.5W min., 5V min., 10mA min.	2x10 ⁵ ops min.
	4 form C	04CV	30V DC, 120V AC- 5A	120V DC, 250V AC	5A	150W, 600VA	0.5W min., 5V min., 10mA min.	1x10 ⁵ ops min.
	4 form C	04CL	30V DC, 120V AC- 3A	120V DC, 250V AC	5A	90W, 360VA	5V DC-1mA min.	2x10 ⁵ ops min.
Heavy load	4 form C bifurcated	04CT	30V DC, 120V AC- 1A	120V DC, 250V AC	2A	30W, 120VA	1V DC-1mA min.	2x10 ⁵ ops min.
	1 form C	01CK	30V DC, 240V AC-15A	120V DC, 250V AC	15A	450W, 3,600VA	0.5W min., 5V min., 10mA min.	2x10 ⁵ ops min.
	1 form A	01AK	30V DC, 240V AC-15A	120V DC, 250V AC	15A	450W, 3,600VA	0.5W min., 5V min., 10mA min.	2x10 ⁵ ops min.
	2 form C	02CK	30V DC, 240V AC-10A	120V DC, 250V AC	10A	300W, 2,400VA	0.5W min., 5V min., 10mA min.	5x10 ⁵ ops min.

- * When the switching voltage exceeds the rated contact voltage, reduce the current.
 Since current values vary according to the type of load, consult your dealer.
- ** Values are measured when switching a resistive load at normal temperature and humidity in clean surroundings.
 Note that the minimum applicable load varies according to the switching frequency and operating environment.

Reference Data

Ambient temperature and operating voltage range

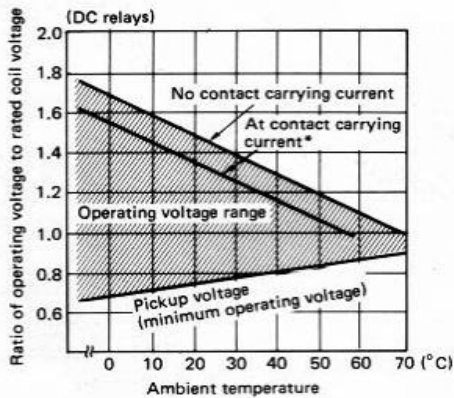

DC load life expectancy curve

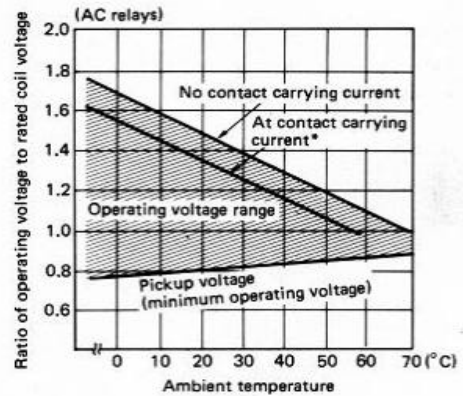

* Rated current in all contacts

DC load life expectancy curve

- | | |
|----------------------|--------------------------------|
| (A) 01CK, 01AK | (1) DC 30VR load |
| (B) 02CK | (2) DC 30V L load (L/R=0.026) |
| (C) 01CS, 02CV, 03CS | (3) DC 100VR load |
| (D) 04CS | (4) DC 100V L load (L/R=0.026) |
| (E) 04CV | |
| (F) 04CT | |

AC load service life curve

- | | |
|----------------------|----------------------|
| (A) 01CK, 01AK | |
| (B) 02CK | (1) 100V AC (R load) |
| (C) 01CS, 02CV, 03CS | (2) 100V AC (L load) |
| (D) 04CS | |
| (E) 04CV | |
| (F) 04CT | |

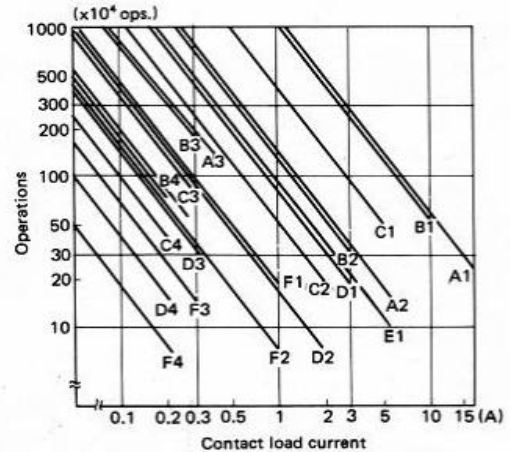
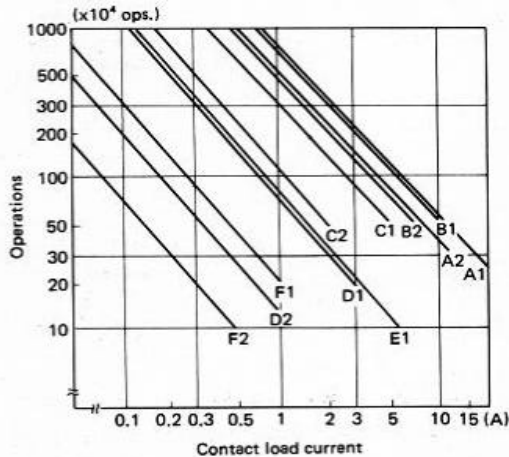

MOBICON
 Electronic Components

Dimensions (medium load type)

Unit: mm (in.)

● Solder, plug-in terminals
1 form C

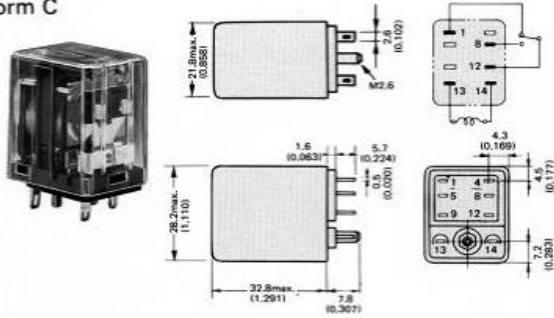

2 form C

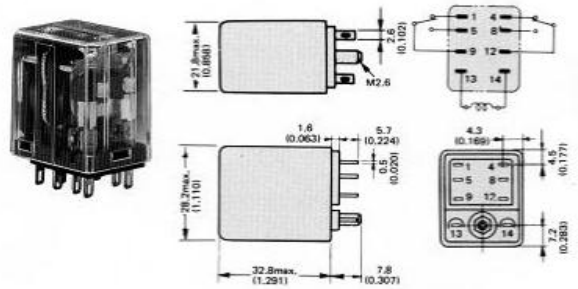

3 form C

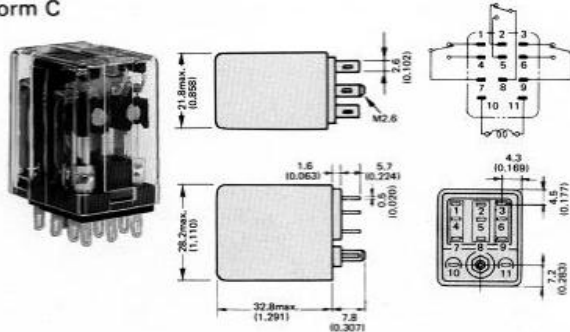

4 form C

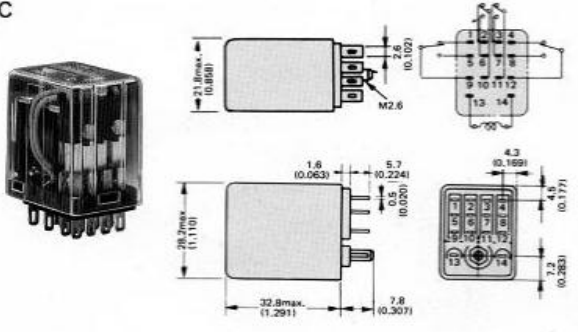

● PC board terminals (1.0 mm (0.039 in.) terminal width)

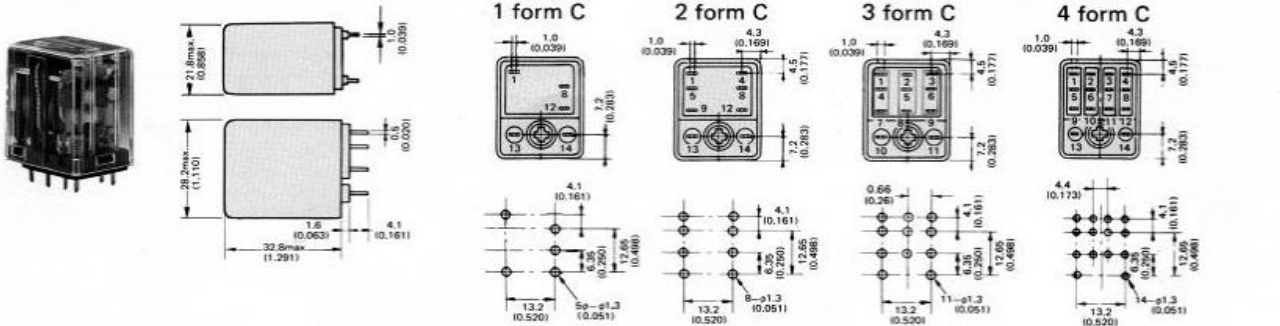

● PC board terminals (1.5 mm (0.059 in.) terminal width)

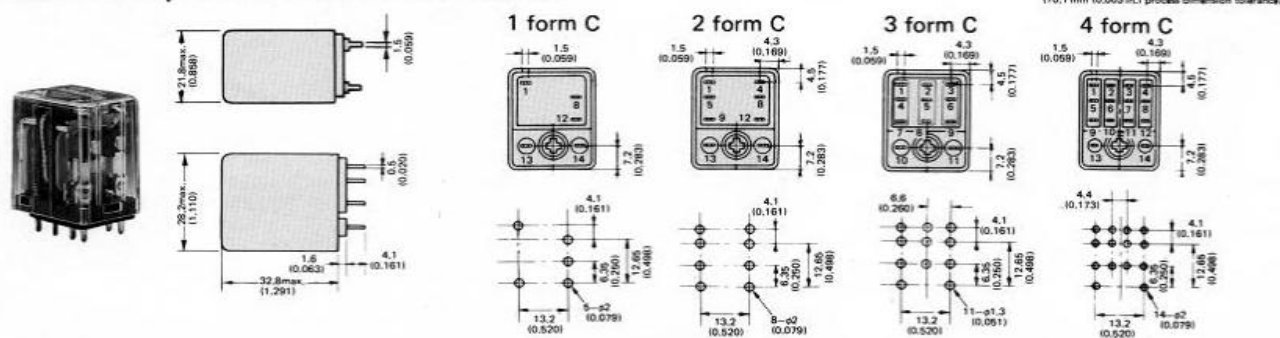

Dimensions (heavy load type)

• Plug-in terminals



1 form C

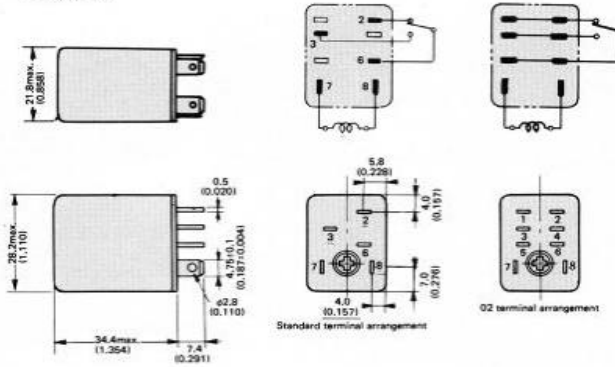

2 form C

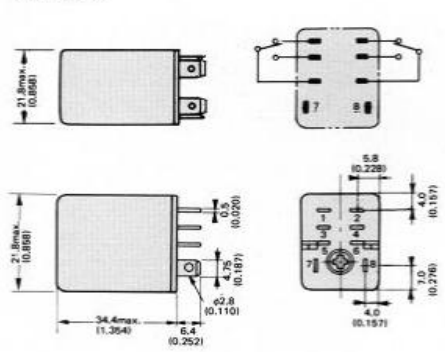

• PC board terminals



1 form C

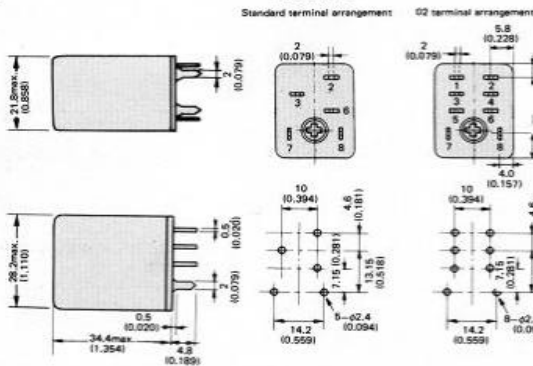

1 form A

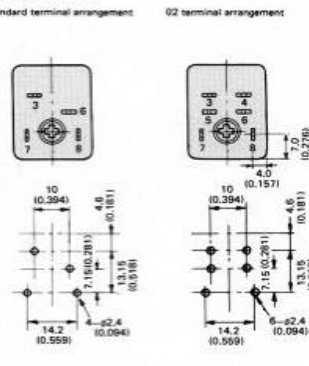

2 form C

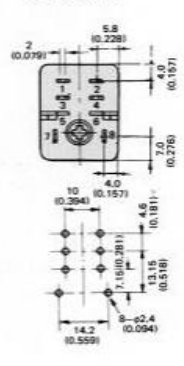

PC board mounting hole layout (±0.1 mm (0.003 in.) process dimension tolerance)

• Bracket case (upside fixing)

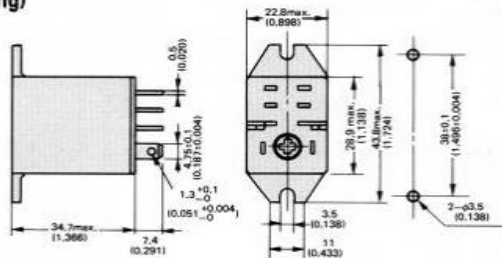
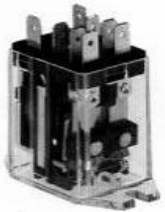

- Photograph and figures show heavy load, 2 form C, quick-connect terminals. The same dimensions apply to other upside fixing types (including the medium load).
- When using quick-connect terminals, use 0.3t or 0.32t of #187 series connectors.

• Bracket case (bottom fixing)

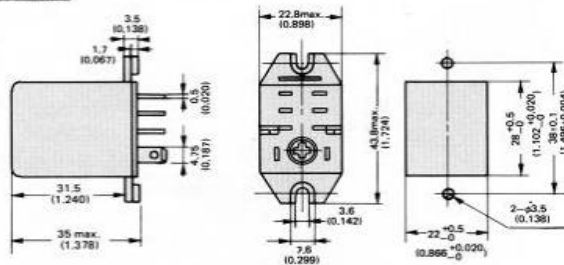

- Photograph and figures show heavy load, 2 form C, solder terminals. The same dimensions apply to other bottom fixing types (including the medium load).

MOBICON
Electronic Components

International Safety Standards

All FRL-260 Relays in this catalog except those with surge-absorbing diodes are available in UL (CSA) recognized types. (Standard types are UL recognized.)

UL recognized and CSA certified

Load	Contact arrangement	Contact designation	Rated coil voltage	UL, CSA contact rating
Medium load	1 form C	/01CS	6V DC to 110V DC	30V DC, 120V AC, 5A, 120V AC, 1/6HP
	2 form C	/02CV		30V DC, 240V AC, 7A, 120V AC, 1/6HP
	3 form C	/03CS		30V DC, 120V AC, 5A, 120V AC, 1/6HP
	4 form C	/04CS /04CL	6V AC to 240V AC	30V DC, 120V AC, 3A, 120V AC, 1/10HP
	4 form C	/04CV		30V DC, 240V AC, 5A, 120V AC, 1/6HP
	4 form C	/04CT		30V, DC, 120V AC, 1A, 120V AC, 1/10HP
Heavy load	1 form C	/01CK	6V DC to 110V DC	30V DC, 150V AC, 15A, 240V AC, 10A, 120V AC, 1/3HP, 240V AC, 1/2HP
	1 form A	/01AK	6V AC to 240V AC	
	2 form C	/02CK		

Special Functions

• With operation display lamp

During relay operations, status is displayed by LEDs and neon lamps in the relays.

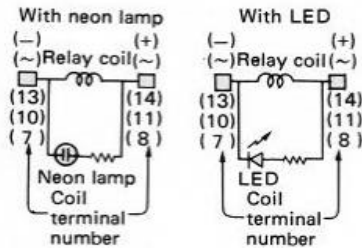
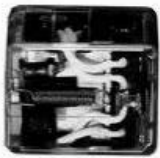

Display	Rated coil voltage
LED	6, 12, 24, 48V DC
	6, 12, 24, 48V AC
Neon lamp	100, 110V DC
	100, 120, 200, 220, 240V AC

- Note that the rated coil voltage increases over that for standard type when using the display lamp.
LED . . . 2 mA to 3 mA increase
Neon . . . 0.3 mA to 0.4 mA increase

(Designation)

Add -A to the end of the solder plug-in type designation.

For example: **263D024/04CS-A**

• With surge absorbing diode (for DC relay use)

Ideal for circuits where the semiconductor is likely to malfunction or break down because of surges originating in the relay coil.

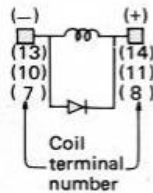

- For DC relay use
- Release time less than 50 ms

(Designation)

Add -S to the end of the solder plug-in type designation.

For example: **263D024/04CS-S**

MOBICON
Electronic Components

● **With arc barrier (for 4 form C use)**

Ideal for circuits with potential differences between adjacent contacts.

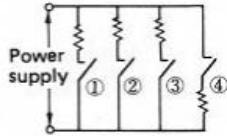
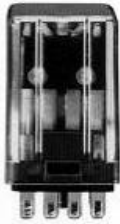

The figure shows the same polarity between contacts 1, 2, and 3, and opposite polarity between contacts 3 and 4. For contact switching with this type of circuit, the potential differences between opposite polarity contacts 3 and 4 may cause short circuits. To prevent this, arc barriers are used in the 4 form C with narrow adjacent contact gaps.

(Designation)

Add -20 to the end of the designation.

For example:

- Standard type **263D024/04CS-00-20**
- With operation display lamp **263D024/04CS-A0-20**
- With bracket case **263D024/04CS-OE-20**

● **UL/TV standards (file number E63615)**

Ideal for power supply input circuits in audio equipment, televisions, and timers that have large rush currents.



Contact rating	Contact arrangement	Solder, plug-in terminals	PC board terminals	Bracket case (upside fixing)	
				Solder terminals	Quick connect terminals (#187)
TV-5	1 form C	263□/01CK-T	264□/01CK-T	263□/01CK-TE	261□/01CK-TE
	1 form A	263□/01AK-T	264□/01AK-T	263□/01AK-TE	261□/01AK-TE
TV-3	2 form C	263□/02CK-T	264□/02CK-T	263□/02CK-TE	261□/02CK-TE

- Insert the voltage designation in the empty boxes of the designation.
- The dimensions given are for standard types.

● **For audio equipment use**

There are also 4 form A (high break capacity) types with wider contact gaps for use as protection circuits for audio speakers.

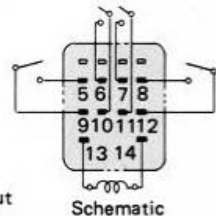
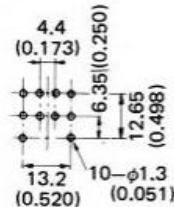
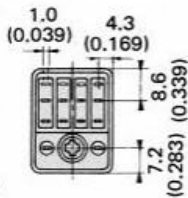
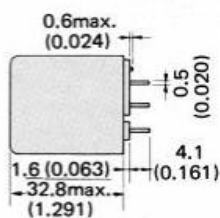
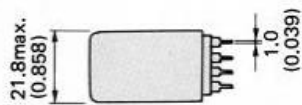

- Three types by rated coil voltage: 12V DC, 24V DC, and 48V DC
- Contact rating and service life: 25,000 ops. min. at 30V DC, 120V AC, 5A resistive load
5,000 ops. min. at 50V AC, 8A (2 contact parallel)

PC board mounting hole layout (±0.1 mm (±0.003 in.) process dimension tolerance)

(Designation)

12V DC example: **264D012/04AL-01**

Unit: mm (in.)

Socket Series

Socket	Load	Contact arrangement	Rear-wired socket						Front-wired socket	
			Solder terminals		Wrapping terminals		PC board terminals		Screw terminals	
			Designation	Wire-latch	Designation	Wire-latch	Designation	Wire-latch	Designation	Wire-latch
Socket	Medium load	1, 2 form C	263H222	Included	263W222	Included	263P222	Included	263S122	Included
		3 form C	263H203	Included	—	—	263P203	Included	263S103	Included
		4 form C	263H204	Included	263W204	Included	263P204	Included	263S104	Included
	Heavy load	1, 2 form C	263H202	Included	—	—	263P202	Included	263S102	Included

Drop protection wire-latch

The wire-latch in the photograph is attached to the socket indicated above by "included" (Leaf springs are sold separately. Please specify N580-2600-X944.)



* Note that when using heavy load sockets, the maximum current is 10 A.

Socket Dimensions

Medium load

Unit: mm (in.)

• Solder sockets (263H204)

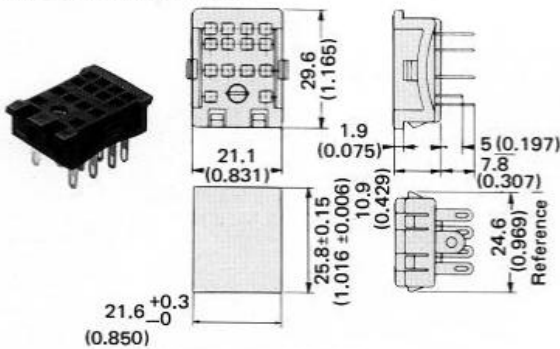

Panel mounting hole layout

Note: Thickness of panel 1 mm (0.039 in.) to 2 mm (0.078 in.) (1.6 mm (0.062 in.) standard)

- The figure and photographs show 263H204 4 form C solder socket. The same dimensions apply to the 263H203 3 form C.
- 1, 2 form C 263H222 with no terminals in the middle two rows is also available.

• Wrapping sockets (263W204)

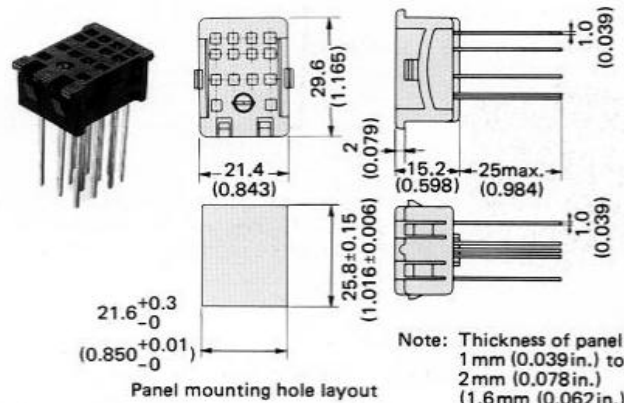

Panel mounting hole layout

Note: Thickness of panel 1 mm (0.039 in.) to 2 mm (0.078 in.) (1.6 mm (0.062 in.) standard)

- The figure shows 263W204 4 form C wrapping socket.
- 1, 2 form C 263W222 with no terminals in the middle two rows is also available.

• PC board sockets

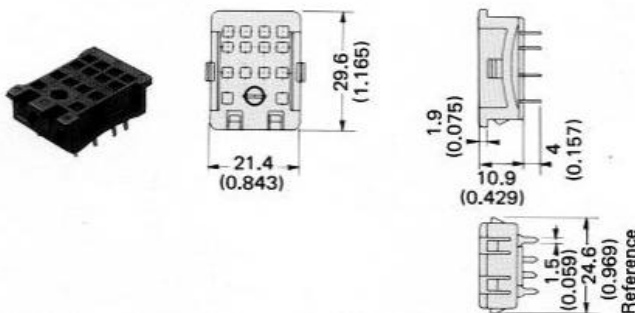

The photograph and figures show the 4 form C types. The same dimensions apply to other types.

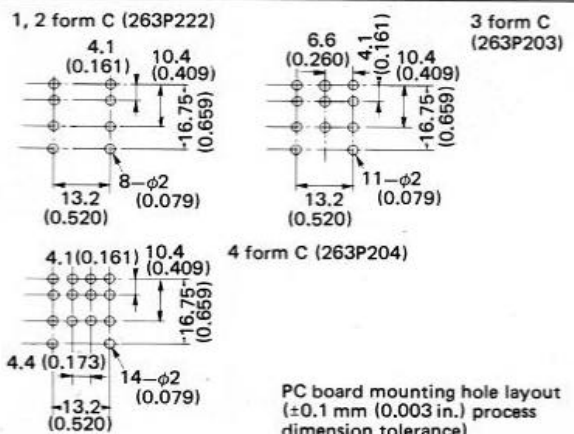

PC board mounting hole layout (±0.1 mm (0.003 in.) process dimension tolerance)

MOBICON
Electronic Components

Heavy load

Unit: mm (in.)

- 1, 2 form C solder sockets (263H202)

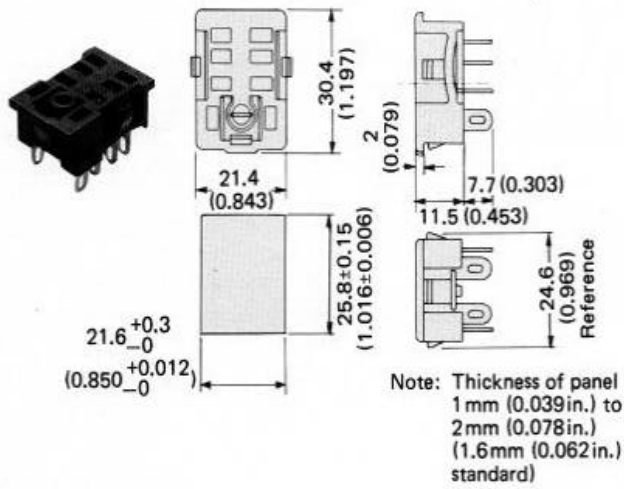

- 1, 2 form C, PC board sockets (263P202)

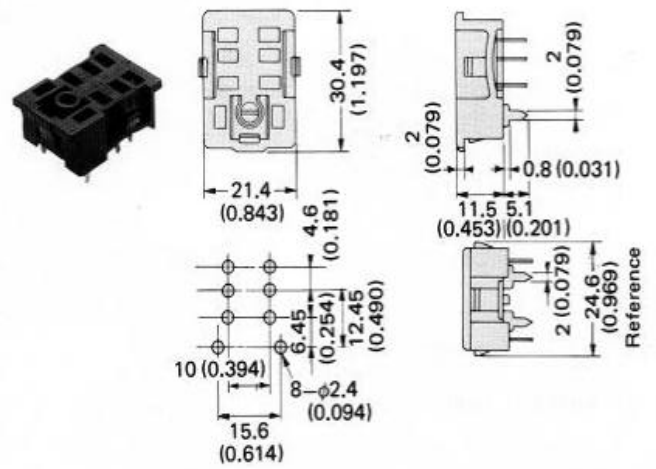

Notes on Installation

Panel mounting

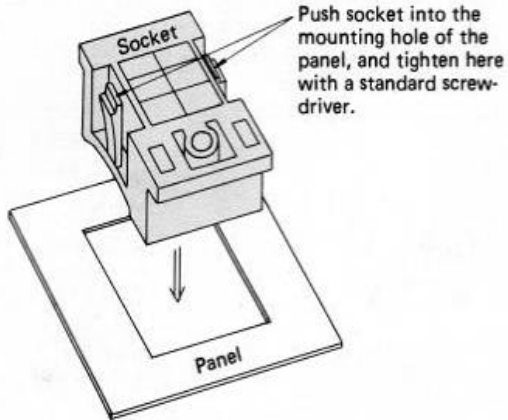

Relay mounting

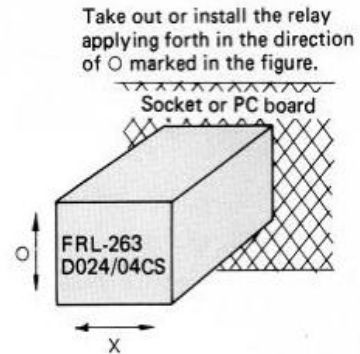

Front-wired sockets (screw)

Unit: mm (in.)

- 1, 2 form C medium load front sockets (263S122)

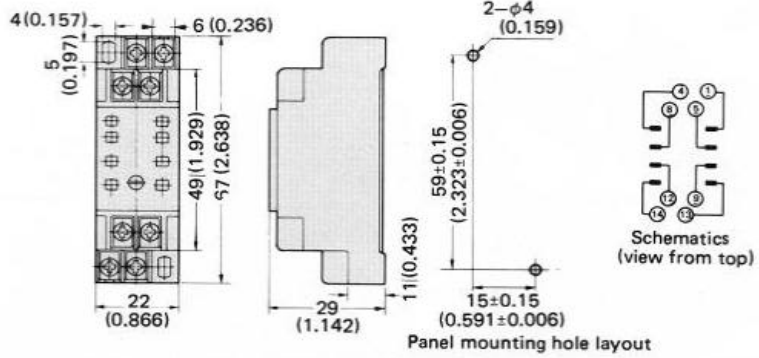

- 3 form C front sockets (263S103)

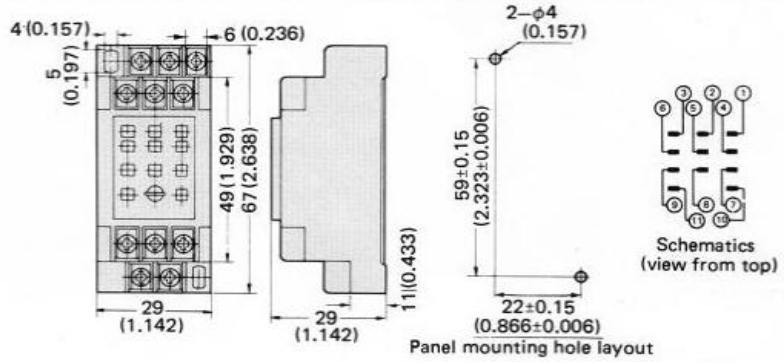
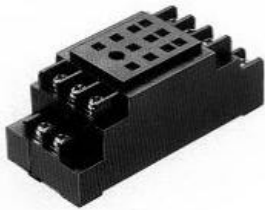

- 4 form C front sockets (263S104)

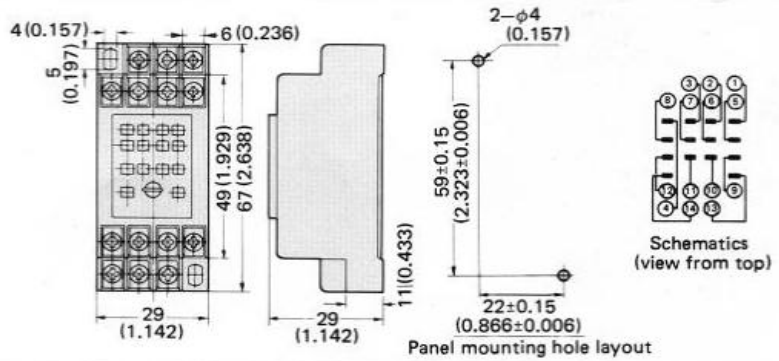

- 1, 2 form C heavy load front sockets (263S102)

