

# LMBR120FT1G thru LMBR1200FT1G

## Schottky Barrier Rectifiers

Reverse Voltage 20 to 200V Forward Current 1.0A

### FEATURES

- \* Plastic package has Underwriters Laboratory Flammability Classification 94V-0
- \* Low power loss, high efficiency
- \* For use in low voltage high frequency inverters, free wheeling, and polarity protection applications
- \* Guardring for over voltage protection
- \* High temperature soldering guaranteed: 260°C/10 seconds at terminals

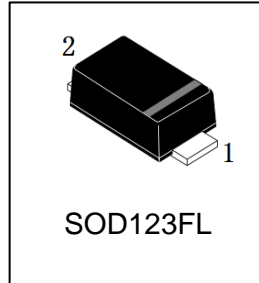

### Mechanical Data

**Case:** SOD123-FL/MINI SMA  
molded plastic over sky die

**Terminals:** Tin Plated, solderable per MIL-STD-750, Method 2026

**Polarity:** Color band denotes cathode end

**Mounting Position:** Any

**Weight:** 0.0155 g

**Handling precaution:** None



We declare that the material of product is Halogen free (green epoxy compound)

### 1. Electrical Characteristic

**Maximum & Thermal Characteristics Ratings at 25°C ambient temperature unless otherwise specified.**

Parameter Symbol	symbol	LMBR 120FT1G	LMBR 130FT1G	LMBR 140FT1G	LMBR 150FT1G	LMBR 160FT1G	LMBR 180FT1G	LMBR 1100FT1G	LMBR 1150FT1G	LMBR 1200FT1G	Unit
device marking code		12	13	14	15	16	18	110	115	120	
Maximum repetitive peak reverse voltage	$V_{RRM}$	20	30	40	50	60	80	100	150	200	V
Maximum RMS voltage	$V_{RMS}$	14	21	28	35	42	56	70	105	140	V
Maximum DC blocking voltage	$V_{DC}$	20	30	40	50	60	80	100	150	200	V
Maximum average forward rectified current at $T_C = 75^\circ C$	$I_{F(AV)}$	1.0									A
Peak forward surge current 8.3ms single half sine-wave superimposed on rated load (JEDEC Method)	$I_{FSM}$	30									A
Power Dissipation	PD	400									mW
Typical thermal resistance (Note 1)	R $\theta$ JA R $\theta$ JL	170 40									$^\circ C/W$
Operating junction temperature range	$T_J$	-55 to +150									$^\circ C$
storage temperature range	$T_{STG}$	-65 to +175									$^\circ C$

**Electrical Characteristics Ratings at 25°C ambient temperature unless otherwise specified.**

Parameter Symbol	symbol	LMBR 120FT1G	LMBR 130FT1G	LMBR 140FT1G	LMBR 150FT1G	LMBR 160FT1G	LMBR 180FT1G	LMBR 1100FT1G	LMBR 1150FT1G	LMBR 1200FT1G	Unit
Maximum instantaneous forward voltage at ( $I_F = 0.1 A, T_J = 25^\circ C$ ) ( $I_F = 0.7 A, T_J = 25^\circ C$ ) ( $I_F = 1.0 A, T_J = 25^\circ C$ )	$V_F$	- - 0.5	0.35 0.45 0.50	- - 0.55	- - 0.7	0.85			0.9	0.92	V
Maximum DC reverse current at rated DC blocking voltage $T_A = 25^\circ C$ $T_j = 125^\circ C$	$I_R$	0.5 10									mA
Typical junction capacitance at 4.0V, 1MHz	$C_J$	160									PF

#### NOTES:

1. 8.0mm<sup>2</sup> (.013mm thick) land areas

# LMBR120FT1G thru LMBR1200FT1G

## 2. Ratings and Characteristic Curves (TA = 25°C unless otherwise noted)

Fig. 1 - Forward Current Derating Curve

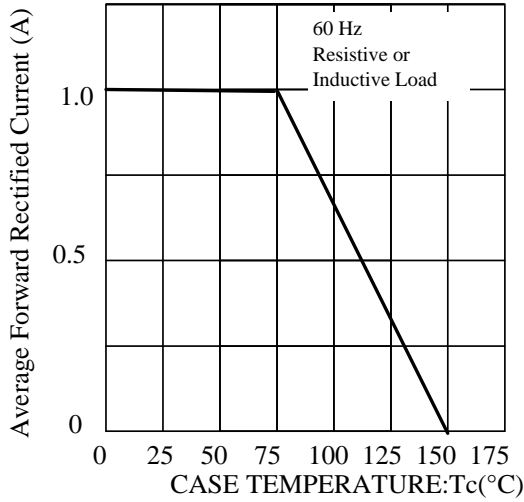

Fig. 2 - Maximum Non-repetitive Peak Forward Surge Current

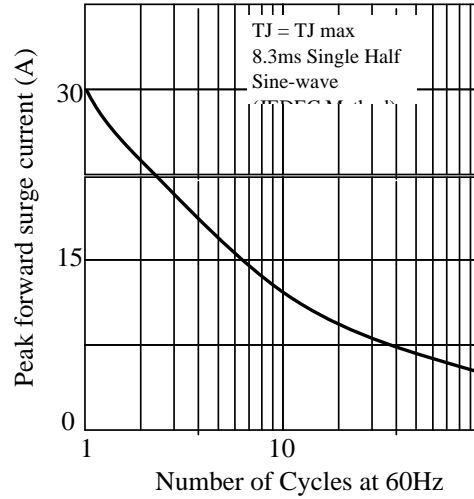

Fig. 3 - Typical Instantaneous Forward Characteristics

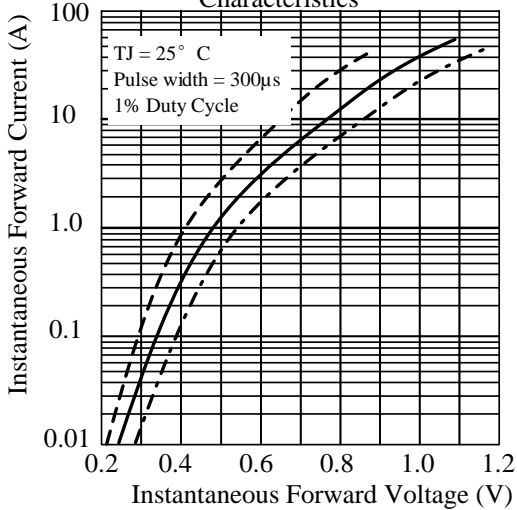

Fig. 4 - Typical Reverse Characteristics

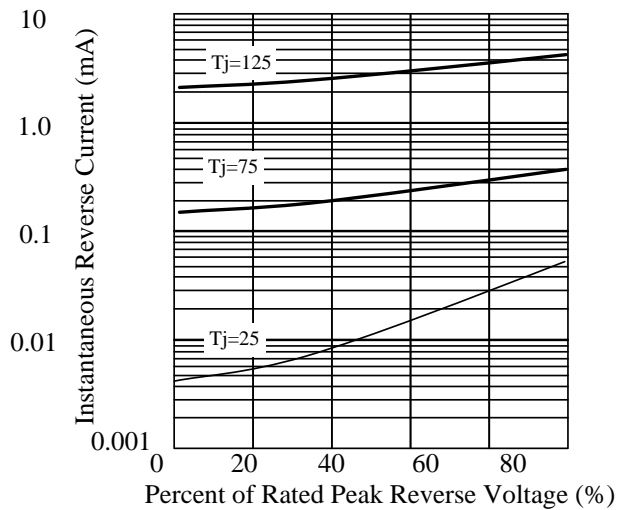

Fig. 5 - typical transient thermal impedance

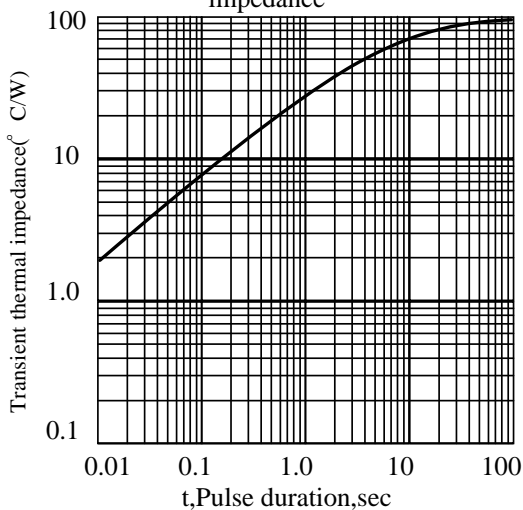
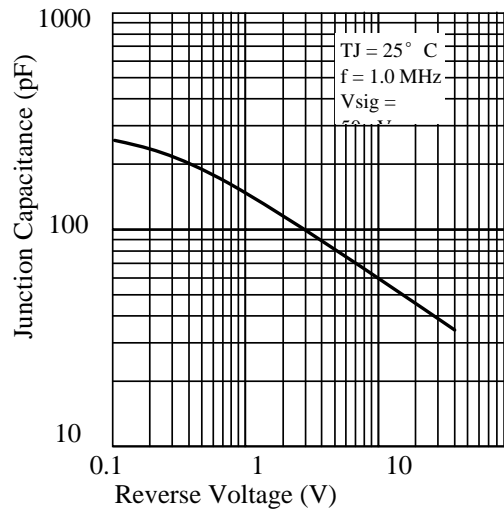
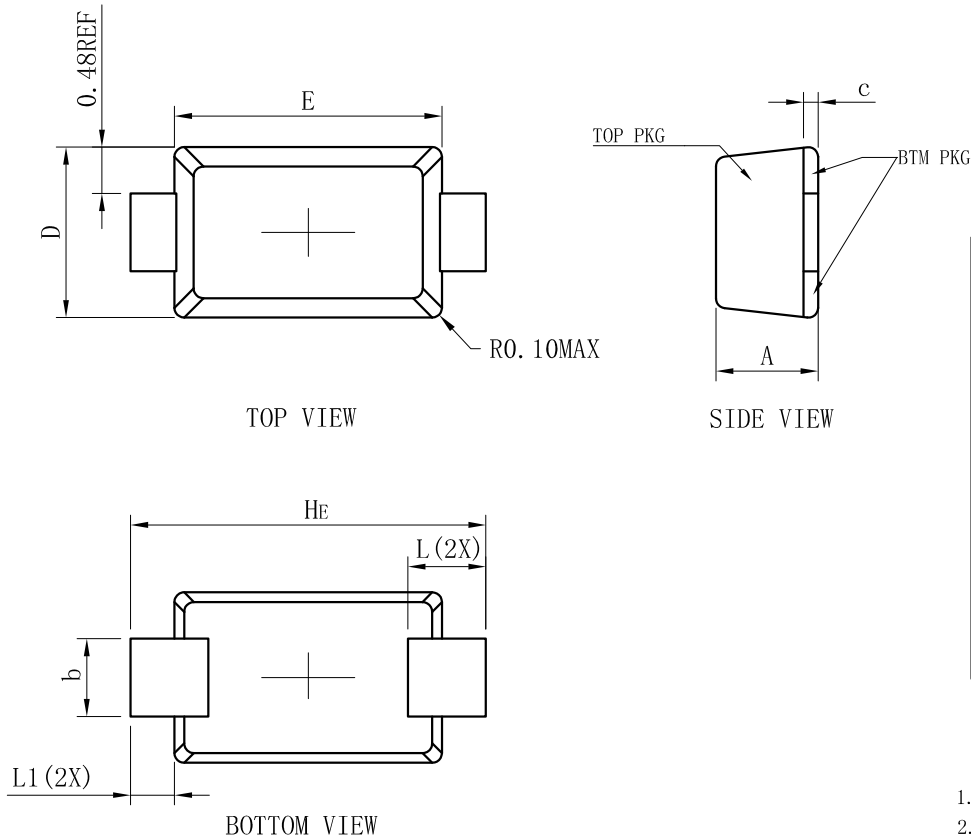

Fig. 6 - Typical Junction Capacitance



### 3.OUTLINE AND DIMENSIONS



SOD123FL			
DIM	MIN	NOR	MAX
A	0.90	1.05	1.15
b	0.75	0.80	0.95
L	0.50	0.80	1.10
E	2.60	2.75	2.90
D	1.60	1.75	1.90
HE	3.50	3.65	3.80
c	0.12	0.17	0.22
L1	0.25	0.45	0.65
All Dimensions in mm			

#### GENERAL NOTES

1. Top package surface finish  $\text{Ra}0.4\pm 0.2\mu\text{m}$
2. Bottom package surface finish  $\text{Ra}0.7\pm 0.2\mu\text{m}$
3. Side package surface finish  $\text{Ra}0.4\pm 0.2\mu\text{m}$

### 4.SOLDERING FOOTPRINT

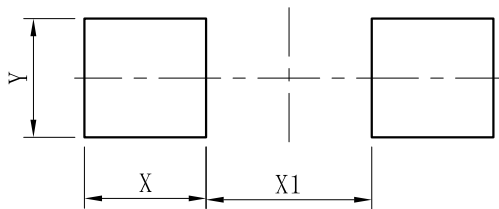

DIM	(mm)
X	1.20
Y	1.10
X1	2.00

# LMBR120FT1G thru LMBR1200FT1G

## 5. Suggested thermal profile for soldering process

1. Storage environment : Temperature=5~40°C Humidity=55±25%
2. Reflow soldering of surface-mount device

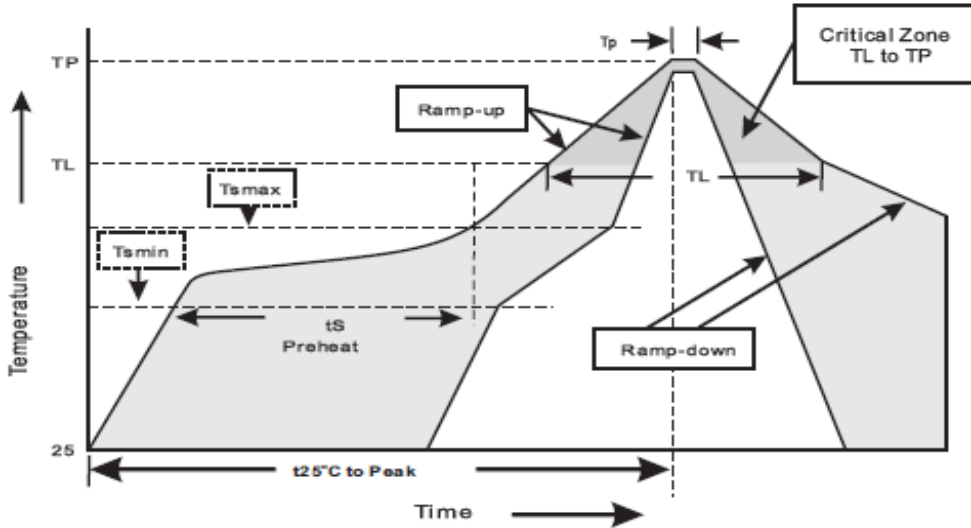

3. Reflow soldering

Profile Feature	Soldering Condition
Average ramp-up rate(T <sub>L</sub> to T <sub>P</sub> )	<3°C/sec
Preheat	
- Temperature Min(T <sub>smin</sub> )	150°C
- Temperature Max(T <sub>smax</sub> )	200°C
- Time(min to max)(t <sub>s</sub> )	60~120sec
T <sub>smax</sub> to T <sub>L</sub>	
- Ramp-up Rate	<3sec
Time maintained above:	
- Temperature (T <sub>L</sub> )	217°C
- Time(t <sub>L</sub> )	60-260sec
Peak Temperature(T <sub>P</sub> )	255 -0/+5°C
Time within 5°C of actual Peak Temperature(T <sub>P</sub> )	10~30sec
Ramp-down Rate	<6°C/sec
Time 25°C to Peak Temperature	<6minutes

## LMBR120FT1G thru LMBR1200FT1G

### 6.High reliability test capabilities

Item Test	Condition	Reference
Solder Resistance	at 260±5°C for 10±2sec immerse body into solder 1/16" ± 1/32"	MIL-STD-750D METHOD-2031
Solderability	at 245±5°C for 5 sec	MIL-STD-202F METHOD-208
High Temperature Reverse Bias	V <sub>R</sub> =80% rate at T <sub>j</sub> =150°C for 168hrs	MIL-STD-750D METHOD-1038
Forward Operation Life	Rated average rectifier current T <sub>A</sub> =25°C for 500hrs	MIL-STD-750D METHOD-1027
Intermittent Operation Life	T <sub>A</sub> =25°C , I <sub>F</sub> =I <sub>O</sub> On state:power on for 5 min. Off state:power off for 5 min. on and off for 500 cycles	MIL-STD-750D METHOD-1036
Pressure Cooker	15P <sub>SIG</sub> at T <sub>A</sub> =121°C for 4hrs	JESD22-A102
Temperature Cycling	-55°C to +125°C dwelled for 30 min. and transferred for 5min. Total 10 cycles	MIL-STD-750D METHOD-1051
Thermal Shock	0°C for 5min. Rise to 100°C for 5min. Total 10 cycles	MIL-STD-750D METHOD-1056
Forward Surge	8.3ms single half sine-wave superimposed on rated load,one surge	MIL-STD-750D METHOD-4066-2
Humidity	at T <sub>A</sub> =85°C , RH=85% for 1000hrs	MIL-STD-750D METHOD-1021
High Temperature Storage Life	at 175°C for 1000hrs	MIL-STD-750D METHOD-1031

## **DISCLAIMER**

- Before you use our Products, you are requested to carefully read this document and fully understand its contents. LRC shall not be in any way responsible or liable for failure, malfunction or accident arising from the use of any LRC's Products against warning, caution or note contained in this document.
- All information contained in this document is current as of the issuing date and subject to change without any prior notice. Before purchasing or using LRC's Products, please confirm the latest information with a LRC sales representative.



Proprietary Information

# Title: Power Packages Product Packing Specification

## 功率产品包装规范

Document Number: APS-QA-QS-009

Revision C

Page 3 of 6



8.1.2 Label position and QA stamp position.(Empty area) 标签张贴位置及QA印章位置。(印章盖在标签空白区)



7英寸卷盘标签张贴及QA印章位置



13英寸卷盘标签张贴及QA印章位置

8.1.3 Ensure direction In the same reel. The same steel coil plate direction, With antistatic bubble to package reel. Refer to the below picture.  
同一箱内的卷盘方向一致,用防静电泡沫对卷盘进行包裹。

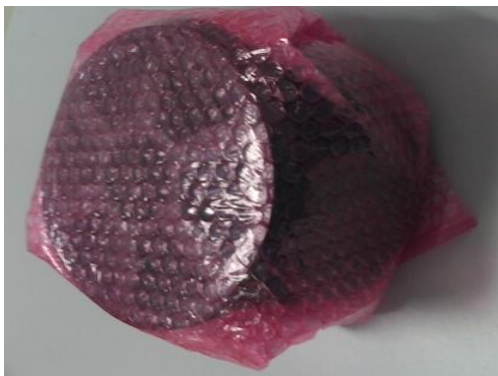

7英寸卷盘防静电泡沫包裹



13英寸卷盘防静电泡沫包裹



Proprietary Information

# Title: Power Packages Product Packing Specification

## 功率产品包装规范

Document Number: APS-QA-QS-009

Revision C

Page 4 of 6

8.1.4 Put in the antistatic packing box after packaged reels. And QA stamp on the box label .

将包装好的卷盘放入防静电纸箱中，并在盒标签上盖章。



7 英寸卷盘内盒及标签



13 英寸卷盘内盒及标签

8.1.5 Product use printing inner box. 产品使用LRC印字内箱。



7英寸卷盘内箱印字（侧面）



13英寸卷盘内箱印字（正面）

8.1.6 Inner box packing quantity requirement. 内盒包装数量要求。

Product Description	QTY
SOD123-FL	1-10Reels
SOD323-HE	1-10Reels
SMA-FL	1-7Reels
SMB-FL	1-4Reels

8.1.7 With transparent tape sealing. 透明胶带封箱。





Proprietary Information

# Title: Power Packages Product Packing Specification

## 功率产品包装规范

Document Number: APS-QA-QS-009

Revision C

Page 5 of 6



7英寸内箱封盒



13英寸内箱封盒

### 8.1.8 Outer box size and packing quantity requirement, 外箱尺寸及包装数量要求。

Product Description	卷盘尺寸	Height (H)	Width (W)	Length (L)	Max. Qty
Power Device	7 英寸	410mm	400mm	445mm	12
Power Device	13 英寸	410mm	400mm	445mm	5



7 英寸卷盘产品装箱



13 英寸卷盘产品装箱

统一方向



Proprietary Information

# Title: Power Packages Marking & Taping Specification

## 功率封装字模和编带规范

Document Number: APS-QA-QS-010

Revision C

Page 6 of 9

### 8.2 Standard Products Taping Specification

标准产品编带规范

#### 8.2.1 Tape length of no component

空带长度说明

Taping leader length 引导部分: 440mm±40mm , Tape trailer 尾部: 200mm±40mm

Figure 4

Tape Ends For Finished Goods Reel



#### 8.2.2 Component packaging orientation: The cathode lead is close to the carrier tape's index hole.

产品放置方向: 印阴极带引脚邻近载带索引孔





Proprietary Information

# Title: Power Packages Marking & Taping Specification

功率封装字模和编带规范

Document Number: APS-QA-QS-010

Revision C

Page 7 of 9

## 8.2.3 Tape enwind orientation

编带缠绕方向要求

