

# Micro & Reed-Alarm Switches

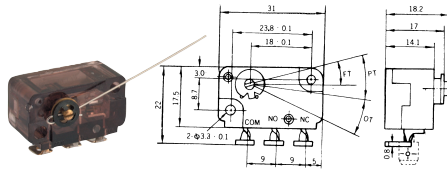

**B181A**  
LOW TORQUE SWITCH  
(SPDT) ON-ON  
250V 3A



**B181L**  
PUSHBUTTON SWITCH  
(SPDT) ON-ON  
250V 5A

COLOR:RED YELLOW  
GREEN BLUE ORANGE  
WHITE

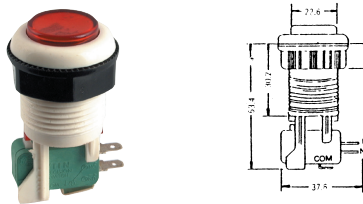

**B181M**  
ILLUMINATED PUSHBUTTON  
SWITCH W/O LAMP  
(SPDT) ON-ON  
12V 1A

COLOR:RED YELLOW  
GREEN BLUE

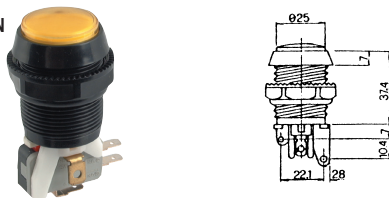

**B181N**  
ILLUMINATED PUSHBUTTON  
SWITCH W/O LAMP  
(SPDT) ON-ON  
12V 1A

COLOR:RED YELLOW  
GREEN BLUE

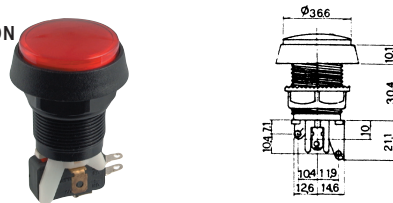

**B181P**  
ILLUMINATED PUSHBUTTON  
SWITCH W/O LAMP  
(SPDT) ON-ON  
12V 1A

COLOR:RED YELLOW  
GREEN BLUE WHITE  
PINK



**B181Q**  
ILLUMINATED PUSHBUTTON  
SWITCH W/O LAMP  
(SPDT) ON-ON  
12V 1A

COLOR:RED YELLOW  
GREEN BLUE WHITE  
PINK



**B182C**  
OMNIPOTENT JOYSTICK  
ON-OFF  
12V 1A

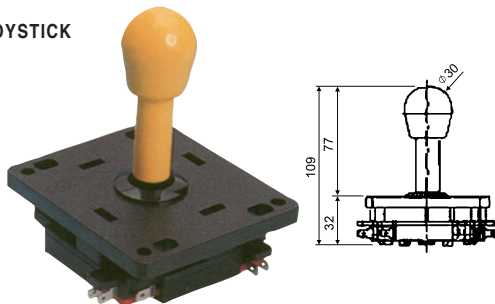

**B182D**  
OMNIPOTENT JOYSTICK  
ON-OFF  
12V 1A

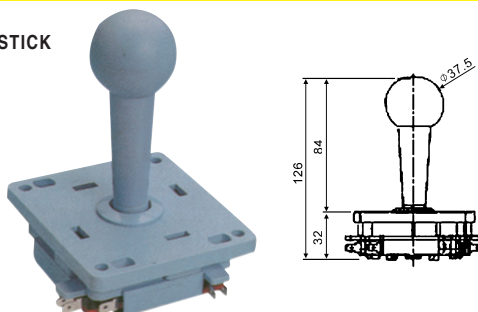

**B182G (B1950)**  
REED-ALARM SWITCH PUSH ON TYPE  
OPERATING GAP 3.5mm MAX

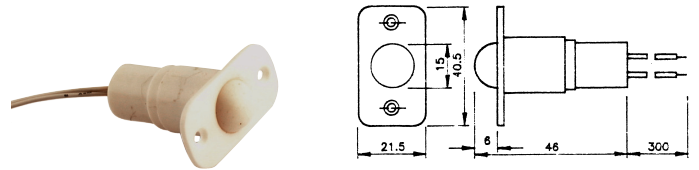

**B182H (B1951)**  
REED-ALARM SWITCH NC TYPE  
OPERATING GAP 2cm MAX

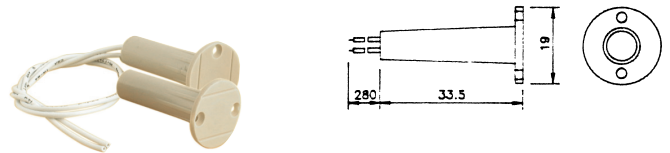

**B182J (B1952)**  
REED-ALARM SWITCH NC TYPE  
OPERATING GAP 2.3cm MAX

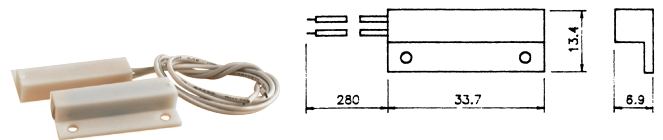

**B182K (B1953)**  
REED-ALARM SWITCH NO AND NC  
TYPE

**B182M (B1954)**  
REED-ALARM SWITCH NC TYPE



**B182N (B1955)**  
REED-ALARM SWITCH NO TYPE  
OPERATING GAP 3cm MAX

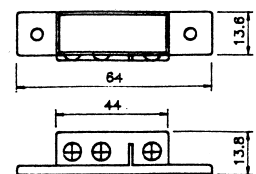

**B182P (B1956)**  
REED-ALARM SWITCH NC TYPE  
OPERATING GAP 3.5cm MAX

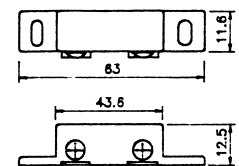

**B182R (B1957)**  
REED-ALARM SWITCH NC TYPE  
DUST PROOF  
OPERATING GAP 4cm MAX

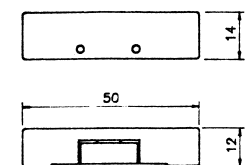

**B182S (B1958)**  
REED-ALARM SWITCH NC TYPE  
DOUBLE-DECK SHELL TO CIONCEAL  
SCREW HOLD  
OPERATING GAP 3.2cm MAX

