

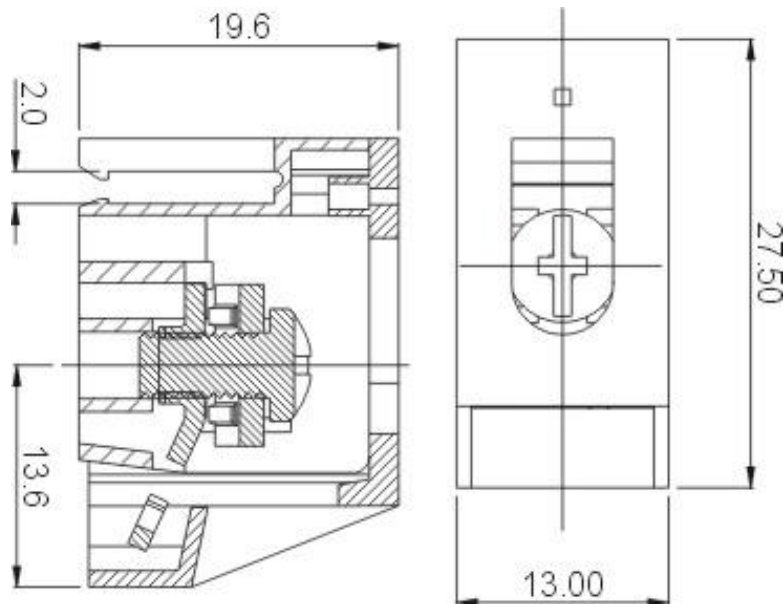





**TSB4**

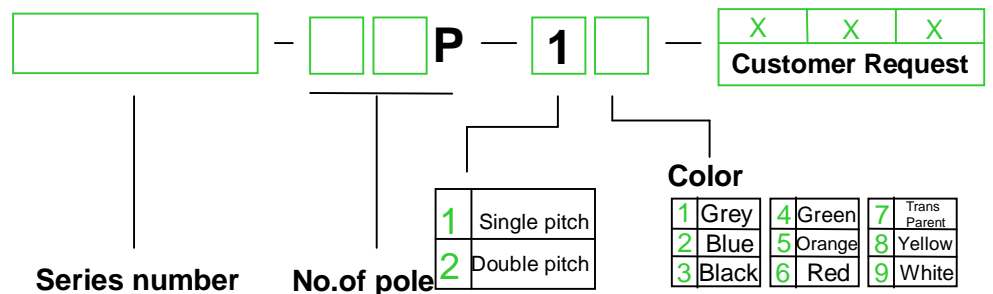

|                      |   |   |
|----------------------|---|---|
| <b>APPROVAL</b>      |  |  |
| <b>Electrical</b>    |   |   |
| Standard             | <b>UL</b>   | <b>IEC</b>  |
| Rated voltage        | 600V  | 450V  |
| Rated current        | 30A   | 32A   |
| Wire range           | 20-12AWG  | 0.5-4.0mm <sup>2</sup>  |
| Withstanding voltage | AC2500V/1Min  |   |
| <b>Mechanical</b>    |   |   |
| Torque               | 1.2Nm(10.5Lb-In)  |   |
| Ambient temperature  | -40°C~+105°C  |   |
| Strip length         | 8-10mm  |   |
| <b>Dimensions</b>    |   |   |
| Pitch                | 13.0mm(.512" )  |   |
| Poles                | 1P  |   |
| <b>Material</b>      |   |   |
| Housing              | PA66,UL94V-0  |   |
| Screws               | M4, Steel,Cr <sup>3+</sup> Zn plated  |   |
| Contact              | Copper, Tin plated  |   |

### HOW TO ORDER :

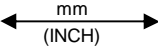

|   |   |
|---|---|
|  |  <b>DEGSON ELECTRONICS CO., LTD.</b> |
|  | <b>NAME</b><br><b>TSB4</b>  |