



■ Features :

- True sine wave output (THD<3%)
- High surge power up to 3000W
- U.P.S. mode and energy saving mode (selectable)
- High efficiency up to 91%
- Power ON-OFF switch
- Standby saving mode can be selectable
- Front panel indicator for operation status
- Thermostatically controlled cooling fan
- Protections: Bat. low alarm / Bat. low shutdown / Over voltage / Over temp. / Output short / Input polarity reverse / Overload / AC circuit breaker
- Application : Home appliance, power tools, office and portable equipment, vehicle and yacht ...etc.
- Built-in solar / AC charger
- Optional monitoring software
- 3 years warranty



**SPECIFICATION**

MODEL	TN-1500-112□	TN-1500-124□	TN-1500-148□	TN-1500-212□	TN-1500-224□	TN-1500-248□		
OUTPUT	RATED POWER (Typ.)		1500W					
	MAXIMUM OUTPUT POWER (Typ.)		1725W for 180 sec. / 2250W for 10 sec. / surge power 3000W for 30 cycles					
	AC VOLTAGE		Factory setting set at 110VAC 100 / 110 / 115 / 120VAC selectable by setting button S.W		Factory setting set at 230VAC 200 / 220 / 230 / 240VAC selectable by setting button S.W			
	FREQUENCY		60±0.1Hz 50/60Hz selectable by setting button S.W		50±0.1Hz 50/60Hz selectable by setting button S.W			
	WAVEFORM		True sine wave (THD<3%) at rated input voltage					
	AC REGULATION (Typ.)		±3.0%					
	TRANSFER TIME (Typ.)		10ms inverter ↔ by pass					
	SAVING MODE (Typ.)		Load ≤5W will be changed to standby mode					
FRONT PANEL INDICATOR		Battery voltage level, output load level, saving mode, fault and operation status						
INPUT	BAT. VOLTAGE		12V	24V	48V	12V	24V	48V
	VOLTAGE RANGE (Typ.) <small>Note.1</small>		10.5 ~ 15VDC	21 ~ 30VDC	42 ~ 60VDC	10.5 ~ 15VDC	21 ~ 30VDC	42 ~ 60VDC
	DC CURRENT (Typ.) <small>Note.5</small>		150A	75A	37.5A	150A	75A	37.5A
	NO LOAD DISSIPATION		≤18W @ standby saving mode					
	OFF MODE CURRENT DRAW		≤1mA					
	EFFICIENCY (Typ.) <small>Note.2</small>		87%	89%	90%	88%	90%	91%
BATTERY TYPES		Open & sealed Lead Acid						
BATTERY INPUT PROTECTION	FUSE		40A*5	30A*3	30A*2	40A*5	30A*3	30A*2
	BAT. LOW ALARM		11.3±4%	22.5±4%	45±4%	11.3±4%	22.5±4%	45±4%
	BAT. LOW SHUTDOWN		10.5±4%	21±4%	42±4%	10.5±4%	21±4%	42±4%
	REVERSE POLARITY		By internal fuse open					
OUTPUT PROTECTION	OVER TEMPERATURE		82°C ± 5°C	82°C ± 5°C	96°C ± 5°C	68°C ± 5°C	68°C ± 5°C	68°C ± 5°C
	OUTPUT SHORT		Protection type : Shut down o/p voltage, re-power on to recover ; by internal RTH3 detect on heatsink of power transistor					
	OVER LOAD (Typ.)		105 ~ 115% load for 180 sec., 115% ~ 150% load for 10 sec. Protection type : Shut down o/p voltage, re-power on to recover					
	CIRCUIT BREAKER		20A		10A			
	GFCI PROTECTION		Optional (Only type F)				None	
ENVIRONMENT	WORKING TEMP. <small>Note.3</small>		0 ~ +40°C @ 100% load ; 60°C @ 50% load					
	WORKING HUMIDITY		20% ~ 90% RH non-condensing					
	STORAGE TEMP., HUMIDITY		-30 ~ +70°C / -22 ~ +158°F, 10 ~ 95% RH					
	VIBRATION		10 ~ 500Hz, 3G 10min./1cycle, 60min. each along X, Y, Z axes					
SAFETY & EMC	SAFETY STANDARDS		UL458 (only for "GFCI" receptacle-Type F)   None					
	LVD		None		EN60950-1			
	WITHSTAND VOLTAGE		Bat I/P - AC I/P:3.0KVAC Bat I/P - AC O/P:3.0KVAC AC O/P - FG:1.5KVAC					
	EMI CONDUCTION&RADIATION		Compliance to FCC class A		Compliance to EN55022 class B, 72/ 245/ CEE, 95/ 54/ CE, E-Mark			
	EMS IMMUNITY		None		Compliance to EN61000-4-2,3,4,5,6,8,11 ENV50204			
AC CHARGER	CHARGE CURRENT (Typ.)		5.5A	2.7A	1.35A	5.5A	2.7A	1.35A
	CHARGE VOLTAGE		14.3V±4%	28.5V±4%	57V±4%	14.3V±4%	28.5V±4%	57V±4%
SOLAR CHARGER	MAX OPEN CIRCUIT VOLTAGE		25V	45V	75V	25V	45V	75V
	CHARGE CURRENT (max.)		30A					
OTHERS	CONTROL WIRING		RJ11 -RS232 (Option)					
	DIMENSION		420*220*88mm (L*W*H)					
	PACKING		6.85Kg; 2pcs/14.7Kg/1.61CUFT					
NOTE	<p>1. Output derating capacity referenced by curve 1.                  2. Efficiency is tested by 1000W, linear load at 13V, 26V, 52V input voltage.                  3. Output derating capacity referenced by curve 2.                  4. All parameters not specified above are measured at rated load, 25°C of ambient temperature.                  5. DC current is tested by 1500W, linear load at 13V, 26V, 52V input voltage.</p>							

**Instructions for TN-1500 monitoring software**

**1. Installation of TN-1500 unit and PC**

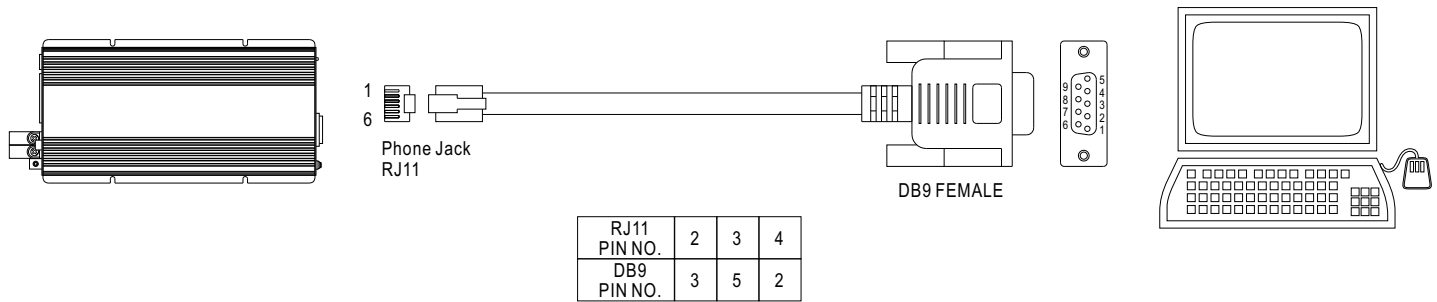

Figure 1

**2. Explanation of Monitoring Manu**

**2.1 Main Page**

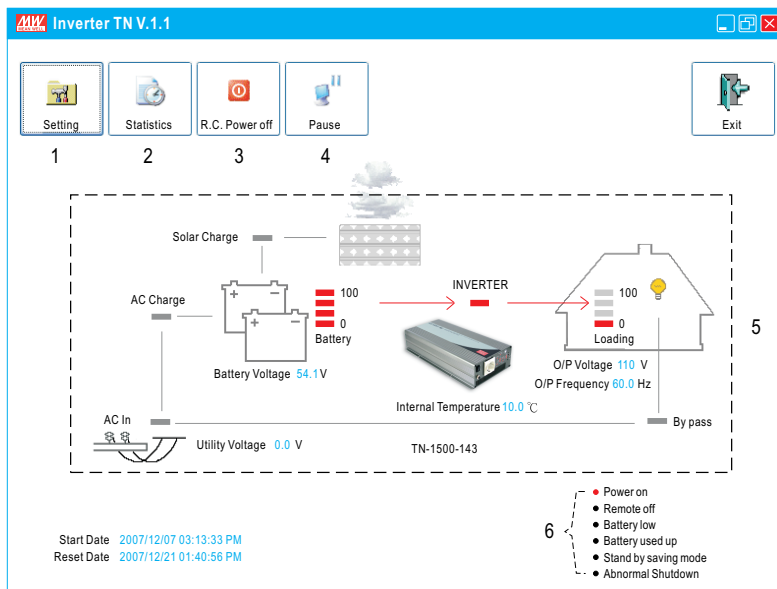

Figure 2

1. Setting: Adjustment for output voltage, charging related voltage, frequency, and operation mode. Please refer to Figure 3 for details.
2. Statistics: Calculate for the percentage of operating period for each operation mode. Please refer to Figure 4 for details.
3. R.C. Power off: Power can be turned ON or OFF at the remote location.
4. Pause: Stop refreshing the page of monitoring software.
5. Status of unit: Indicating current operating status of TN-1500.
6. Signals that display current condition of the unit.

2.2 Setting Page

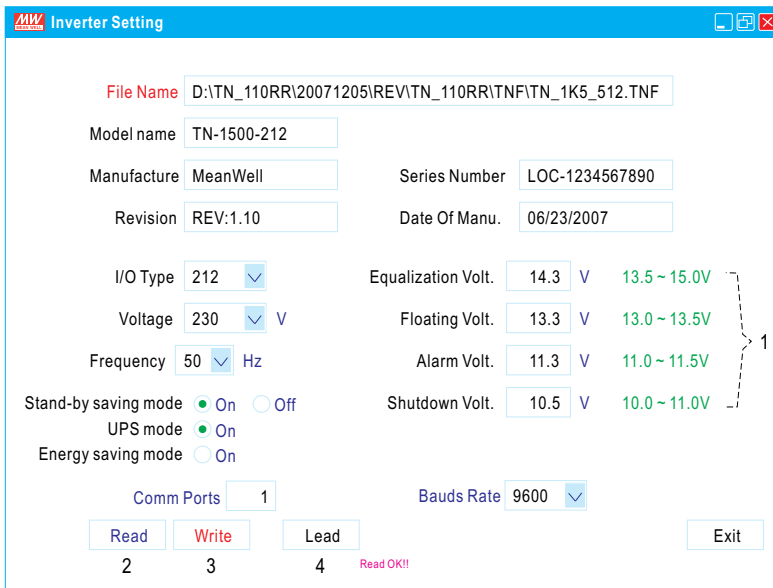

Figure 3

1. User can adjust the settings based on the characteristics of batteries been used: Equalization Voltage, Floating Voltage, Alarm Voltage, and Shut-down Voltage. UPS Mode / Energy Saving Mode selection and AC output voltage and frequency can also be set in this page.
2. Read: Read current settings of the unit.
3. Write: Write the revised setting into the unit.
4. Load: Load in factory default settings.

2.3 Statistic Page

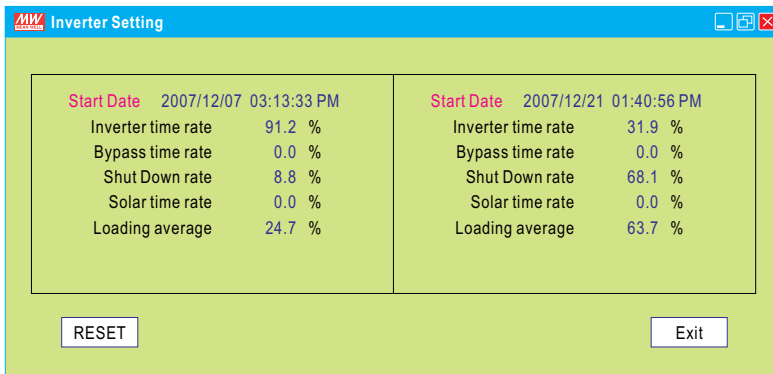
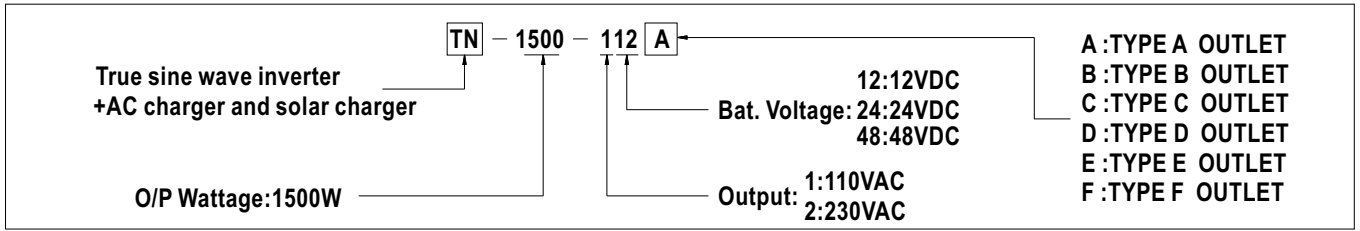

Figure 4

1. Start Date: Date that installing the monitoring software.
2. Reset Date: Date that resetting the statistics. The Start Date will not be influenced by resetting the statistics or turning off the unit.
3. Inverter time rate: Operating period of "Inverter Mode" represents how many percent of the whole operating period.
4. Bypass time rate: Operating period of "Bypass Mode" (energy provides directly by the utility) represents how many percent of the whole operating period.
5. Shut down rate: Percentage of time period that the unit is under the condition of shut down.  
**\* Inverter time rate + Bypass time rate + Shut down rate = 100%**
6. Solar time rate: Percentage of time period that the solar charger is functioning after turning on the TN-1500 unit.
7. Loading average: Average loading after turning on the TN-1500 unit.



■ AC Output Receptacles (optional)

Receptacle type						
	TYPE-A	TYPE-B	TYPE-C	TYPE-D	TYPE-E	TYPE-F
Country	USA	EUROPE	AUSTRALIA	U.K	JAPAN	GFCI
Certificate						

■ Mechanical Specification

Unit:mm

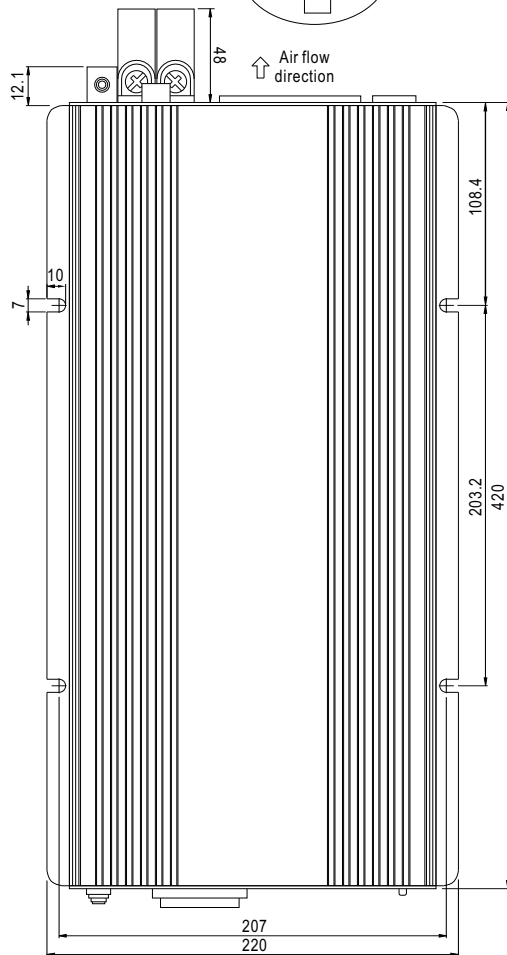
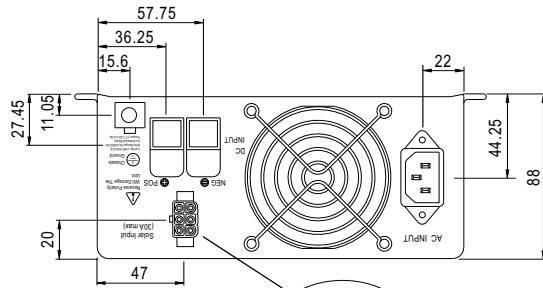

■ Derating Curve

