

Features

- Schottky Barrier Chip
- Guard Ring Die Construction for Transient Protection
- Ideally Suited for Automatic Assembly
- Low Power Loss, High Efficiency
- Surge Overload Rating to 50A Peak
- For Use in Low Voltage, High Frequency Inverters, Free Wheeling, and Polarity Protection Application
- High Temperature Soldering: 260°C/10 Second at Terminal
- Available in Lead Free Version

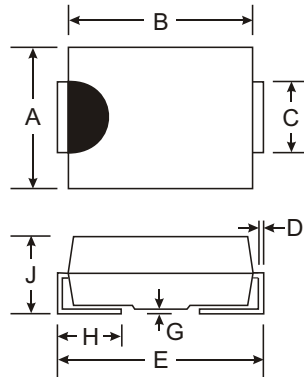

Dim	SMA		SMB	
	Min	Max	Min	Max
A	2.29	2.92	3.30	3.94
B	4.00	4.60	4.06	4.57
C	1.27	1.63	1.96	2.21
D	0.15	0.31	0.15	0.31
E	4.80	5.59	5.00	5.59
G	0.10	0.20	0.10	0.20
H	0.76	1.52	0.76	1.52
J	2.01	2.62	2.00	2.62

All Dimensions in mm

Mechanical Data

- Case: Molded Plastic
- Plastic Material - UL Flammability Classification 94V-0
- Moisture sensitivity: Level 1 per J-STD-020A
- Terminals: Solder Plated Terminal - Solderable per MIL-STD-202, Method 208
- Also Available in Lead Free Plating (Matte Tin Finish). Please See Ordering Information, Note 4, on Page 2
- Polarity: Cathode Band or Cathode Notch
- Approx. Weight: SMA 0.064 grams
SMB 0.093 grams
- Mounting Position: Any
- Marking: Type Number

No Suffix Designates SMB Package
"A" Suffix Designates SMA Package

Maximum Ratings and Electrical Characteristics @ T_A = 25°C unless otherwise specified

Single phase, half wave, 60Hz, resistive or inductive load.
For capacitive load, derate current by 20%.

Characteristic	Symbol	B220/A	B230/A	B240/A	B250/A	B260/A	Unit
Peak Repetitive Reverse Voltage	V _{RRM}	20	30	40	50	60	V
Working Peak Reverse Voltage	V _{RWM}						
DC Blocking Voltage	V _R						
RMS Reverse Voltage	V _{R(RMS)}	14	21	28	35	42	V
Average Rectified Output Current @ T _T = 100°C	I _O	2.0					A
Non-Repetitive Peak Forward Surge Current, 8.3ms single half sine-wave superimposed on rated load (JEDEC Method)	I _{FSM}	50					A
Forward Voltage @ I _F = 2.0A	V _{FM}	0.50		0.70			V
Peak Reverse Current @ T _A = 25°C at Rated DC Blocking Voltage @ T _A = 100°C	I _{RM}	0.5 20					mA
Typical Junction Capacitance (Note 2)	C _j	200					pF
Typical Thermal Resistance, Junction to Terminal	R _{θJT}	20					K/W
Typical Thermal Resistance, Junction to Ambient (Note 1)	R _{θJA}	25					K/W
Operating and Storage Temperature Range	T _j , T _{STG}	-65 to +150					°C

Notes: 1. Thermal Resistance: Junction to terminal, unit mounted on PC board with 5.0 mm² (0.013 mm thick) copper pad as heat sink.
2. Measured at 1.0 MHz and applied reverse voltage of 4.0V DC.

Ordering Information (Note 3 & 4)

Device*	Packaging	Shipping
B2x-13 B2xB-13	SMA SMB	5000/Tape & Reel 3000/Tape & Reel

Notes: 3. For Packaging Details, go to our website at <http://www.diodes.com/datasheets/ap02007.pdf>.

* x = Device type, e.g. B260A-13 (SMA package); B240-13 (SMB package).

4. For lead free terminal plating part number, please add "-F" suffix to part number above. Example: B250-13-F.

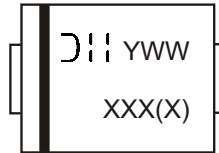

XXX = Product type marking code, ex: B220A (SMA package)
 XXXX = Product type marking code, ex: B230 (SMB package)
 D||| = Manufacturers' code marking
 YWW = Date code marking
 Y = Last digit of year ex: 2 for 2002
 WW = Week code 01 to 52

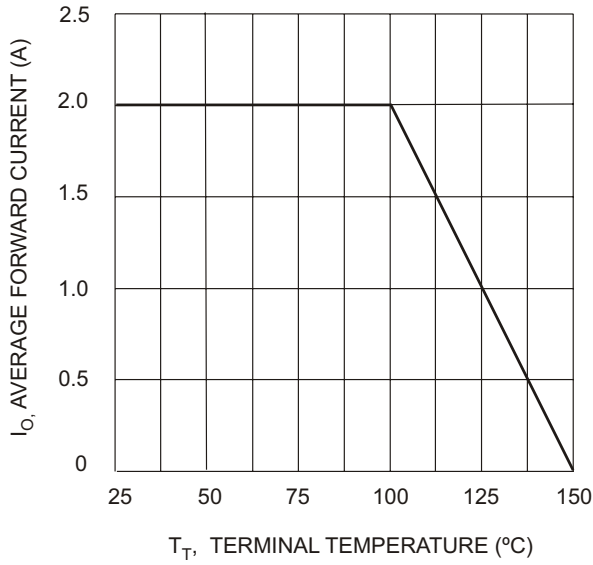

Fig. 1 Forward Current Derating Curve

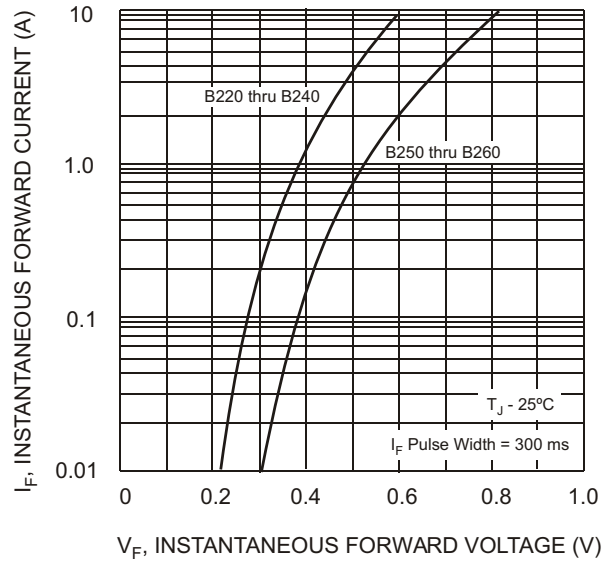

Fig. 2 Typical Forward Characteristics

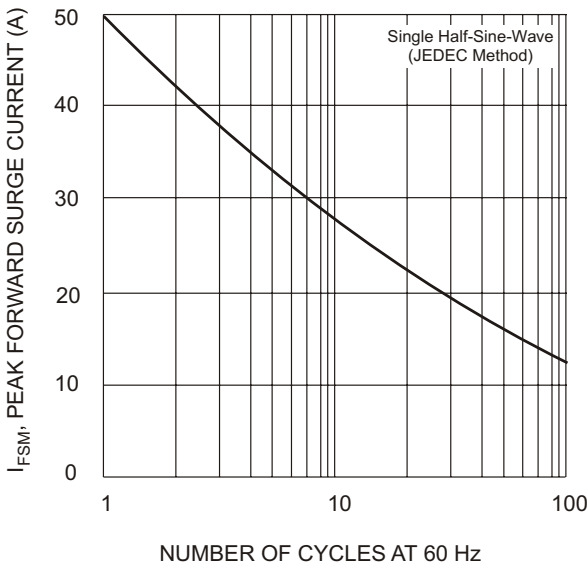

Fig. 3 Max Non-Repetitive Peak Forward Surge Current

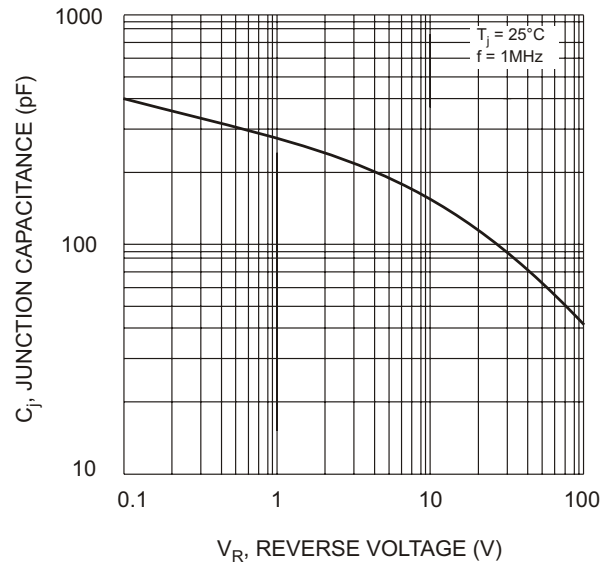

Fig. 4 Typical Junction Capacitance

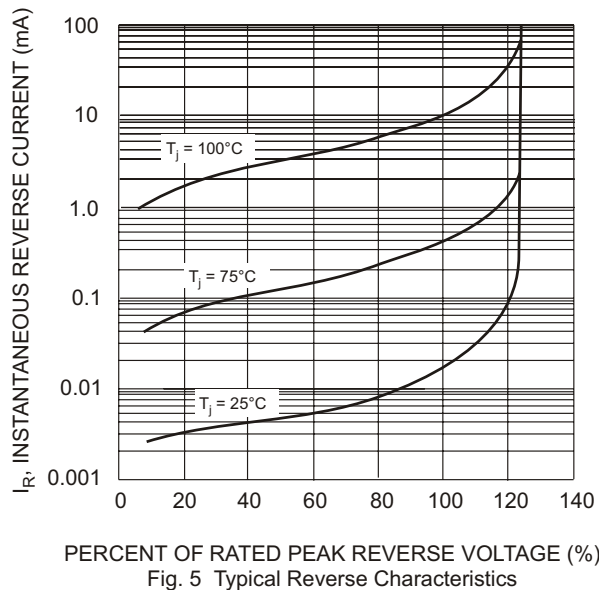

Fig. 5 Typical Reverse Characteristics

This datasheet has been download from:

www.datasheetcatalog.com

Datasheets for electronics components.